

RADIO'S AID TO VOTERS

RADIO NEWS

32
NOVEMBER
25 Cents

1932
Presidential
Campaigns
by Radio

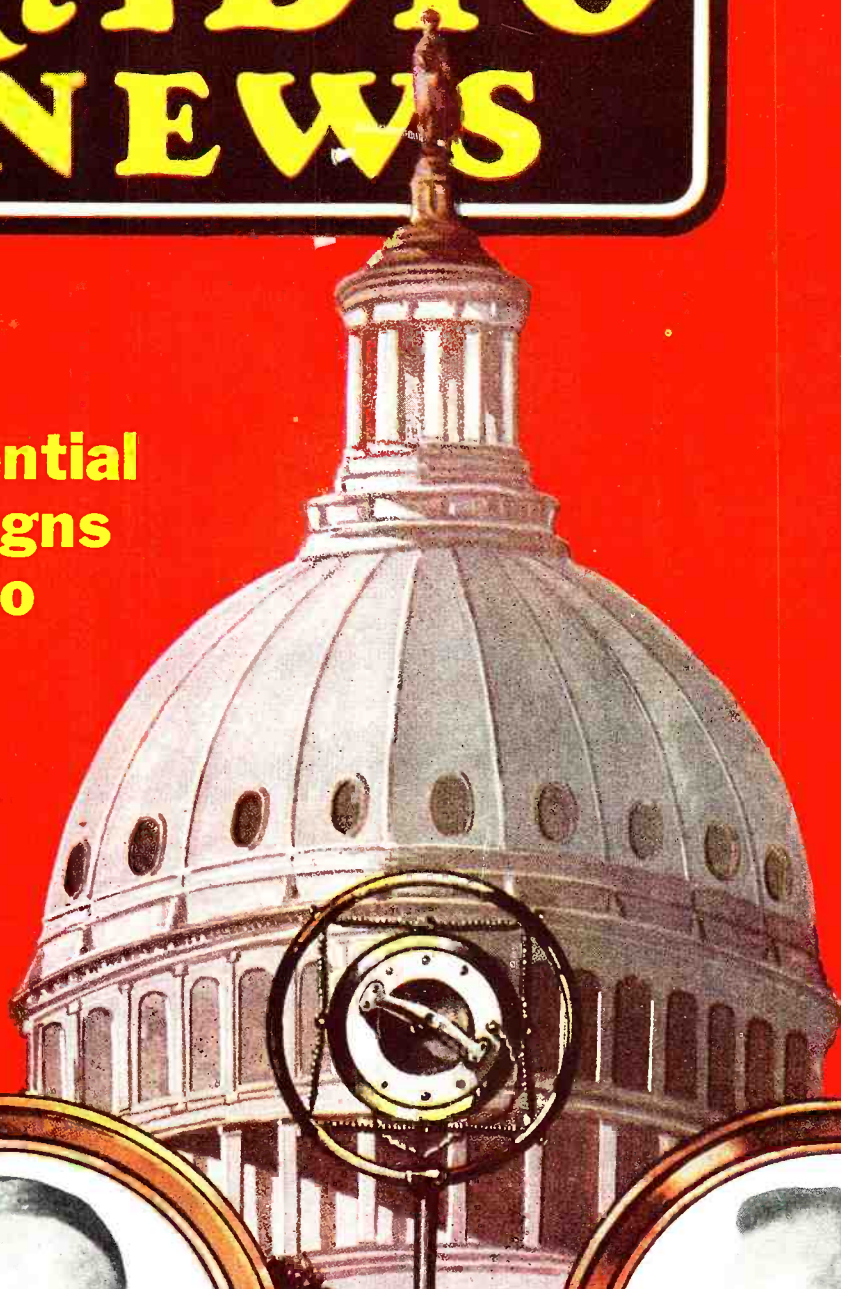

Sight and Sound
on a Single Wave



Killing Static
Public Address

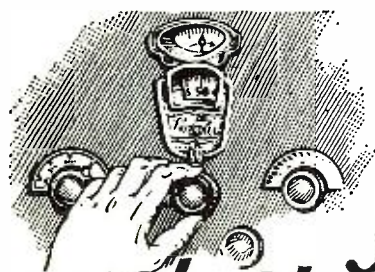

Tune the **NEW** way for World-Wide Reception with the **LINCOLN DE·LUXE·SW·33**

FOR 10 DAYS
RIGHT IN YOUR
OWN HOME
AND YOU WILL
UNDERSTAND

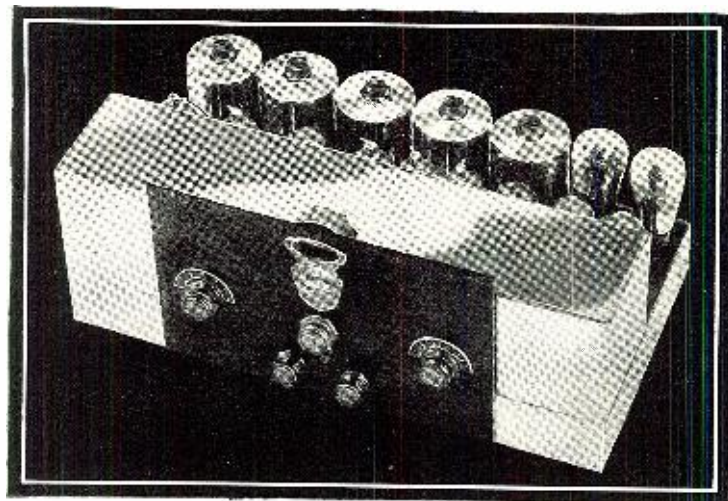

WHY—

*We have not had one single request
for refund on the*

LINCOLN DELUXE SW-33

WHY— Only eight requests for refund were made in the whole previous year, which were promptly made.

WHY— The MacMillan Expedition, professional experts and super-critical fans are so enthusiastic about Lincoln performance.

WHY— Automatic volume control, silent tuning, dual control, allowing full sensitivity with low speaker volume, undistorted high amplification and a range of 15 to 550 meters is giving Lincoln owners 100% satisfaction.

You can buy the Lincoln Deluxe SW-33 on a ten day trial with money back guarantee

LINCOLN RADIO CORPORATION
Dept. N-11, 329 S. Wood St., Chicago, Ill.
Please send information on A.C. D.C. receivers.

Name _____

Address _____

City _____ State _____

Print name and address plainly

LINCOLN
DeLuxe Receivers

Radio Service Work Offers YOU today's Best Earning Opportunity!

TRAIN for it WITH R.T.A.



This excellent set analyzer and trouble shooter included with our course of training

Specially Trained and Equipped Men Are Needed AT ONCE!

Right now vast numbers of all-electric radio receivers in use guarantee a profitable field for certified R. T. A. Service Men. Fit yourself for this work so you can make real money, full time or spare time. Prepare also for other great opportunities in this immense and constantly expanding industry. R. T. A. Training qualifies you . . . certifies you . . . furnishes you with the wonderful Set Analyzer and Trouble Shooter shown here. Using it, you can compete successfully with "old-time" radio men who work by guess—with it you instantly find troubles in any receiver and know how to quickly and efficiently remedy them.

START PROFITING QUICKLY!

There's money in Radio Service Work for you N-O-W! Even before you have completed R. T. A. training, you can start money-making spare time work . . . wire rooms for radio, install public address systems, install and service sets for dealers, put in auto radios, etc. The farther along you get in your training the more big-money chances open up for you. All you need is average intelligence and the will to win success by your own merit. Then earnings as high as \$10 a day are easily possible—you can go into business for yourself—be independent! And R. T. A. Training doesn't stop helping you after you complete the course. It gives you lifetime membership in the R. T. A. that will help you all through your career. R. T. A. is the quick and easy way of getting into Radio—and many say that it's the best way from every point of view.

With this marvel of equipment—plus instructions given you by R. T. A.—you quickly become a real, *certified* Radio Service Expert. You can locate troubles in all kinds of sets, test circuits, detect defective tubes, etc. etc. It's a money-maker for you—and it comes to you, with the knowledge of the proper way to use it—only through R. T. A. Training.

Mail this Coupon NOW!

Delay may cost you dearly! Remember that the quicker you get Training, the quicker you're equipped for money making. Write AT ONCE—find out how easy it is to join the R. T. A.—how you get the Set Analyzer free of extra cost—and why it will be the wisest move you ever made. Send the coupon for all details.

RADIO TRAINING ASS'N OF AMERICA
4513 Ravenswood Ave., Dept. RNA-11, Chicago, Ill.

Radio Training Ass'n of America,
4513 Ravenswood Ave., Dept. RNA-11, Chicago, Ill.

Send me all details regarding membership in the R. T. A., and the Set Analyzer furnished with the course, together with information about the opportunities in Radio today.

Name.....

Address.....

City.....State.....

S. GORDON TAYLOR
Technical Editor

WILLIAM C. DORF
Associate Editor

JOHN M. BORST
Ass't Tech. Editor



HOWARD S. PEARSE
Associate Editor

SAMUEL KAUFMAN
Broadcast Editor

JOS. F. ODENBACH
Art Editor

Edited by LAURENCE M. COCKADAY

VOLUME XIV

November, 1932

NUMBER 5

CONTENTS

(Cover Design by Morcy)

Radio Aids the Voter By Laurence M. Cockaday.....	PAGE 267	A Heavy Duty P. A. System By Bernard J. Montyn.....	PAGE 282
Television and Sound By Samuel Kaufman.....	PAGE 270	5-Meter Measurements By James Millen.....	PAGE 284
Porcelain-built Radio By Paul J. Gordon Fischel.....	PAGE 272	A Laboratory-built "Super" By S. G. Taylor and W. C. Dorf.....	PAGE 286
Rejectostatic Reception By Lewis M. Clement.....	PAGE 274	The Election Special By Nat Pomeranz.....	PAGE 288
Everything on the Air By John M. Borst.....	PAGE 276	The Pocket Diagonometer By D. L. Van Lcuwen.....	PAGE 290
Radio Morons? By V. Michinov and I. J. Saxl.....	PAGE 278	Service Sales Promotion By Zeh Bouck.....	PAGE 296
A Buttonhole Microphone By Thomas Clifton.....	PAGE 281	Testing New Tubes By W. Gerber.....	PAGE 298

DEPARTMENTS

Radio Science Abstracts.....	PAGE 292
Free Booklet Service.....	PAGE 293
The Service Bench.....	PAGE 296
With the Experimenters.....	PAGE 298
Students' Radio Physics Course.....	PAGE 300
Backstage in Broadcasting.....	PAGE 302
QRD.....	PAGE 305
Latest Radio Patents.....	PAGE 306
What's New in Radio.....	PAGE 308

Published Monthly by Teck Publications, Inc., Washington and South Avenues, Dunellen, N. J.

OFFICERS

Lee Ellmaker, *President*
Warren P. Jeffery } *Vice Presidents*
Huston D. Crippen }
Paul Diffenderfer, *Treasurer*
Abner Germann, *Secretary*

EDITORIAL AND EXECUTIVE OFFICES

222 WEST 39th STREET, NEW YORK CITY, N. Y.

Entered as second class matter at the Post Office at Dunellen, N. J., under the act of March 3, 1879. Copyright, 1932, by Teck Publications, Inc. All rights reserved. Title Registered at the U. S. Patent Office. Printed in the United States of America. The contents of this magazine must not be reproduced without permission. We cannot be responsible for lost manuscripts, although every care is taken for their safety.

25c a Copy, \$2.50 a year, \$3.50 in Canada, \$3.50 in Foreign Countries. Subscribers are notified that change of address must reach us five weeks in advance of the next day of issue.

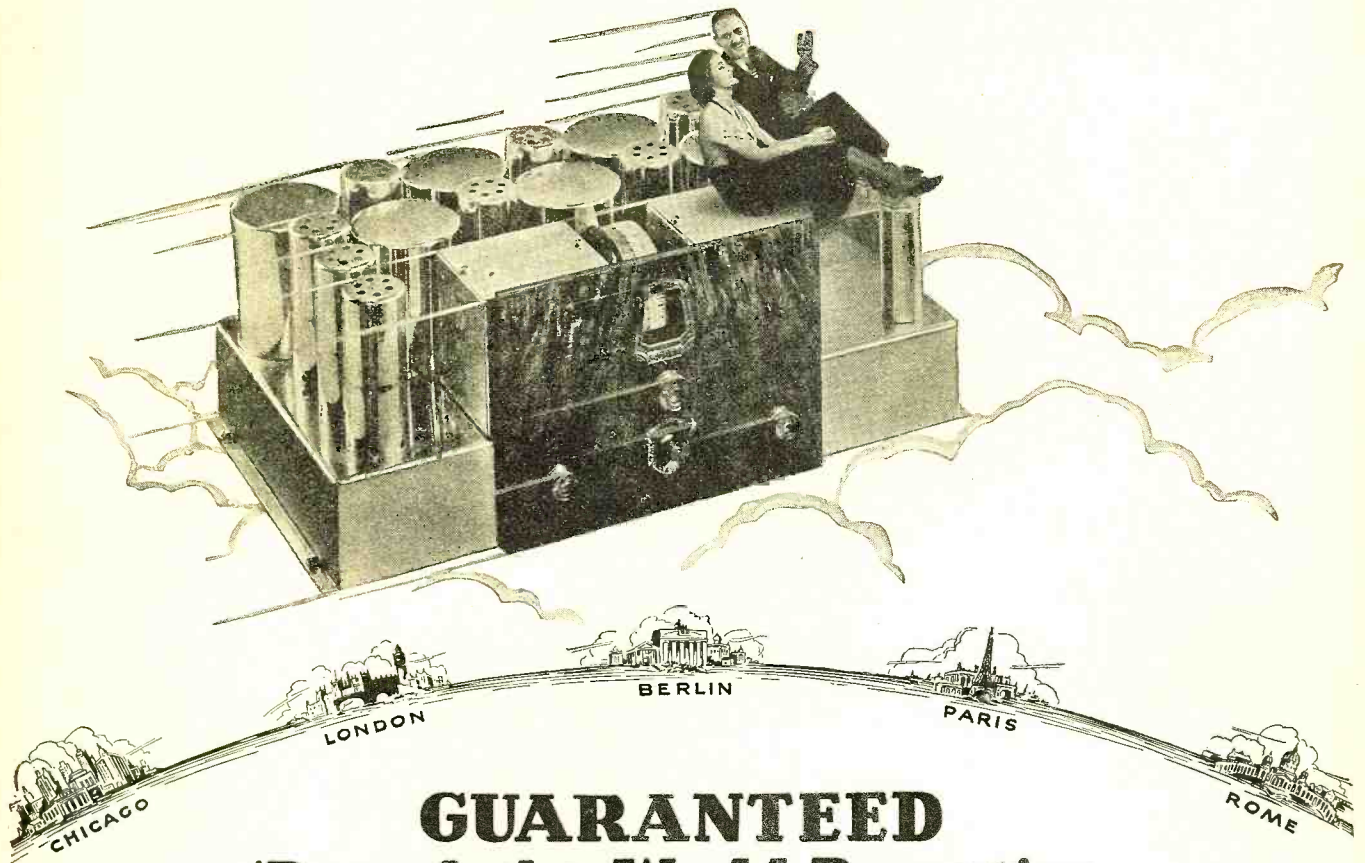

GUARANTEED 'Round-the-World Reception For the First Time in Radio History

JUST turn a switch and—z-i-p! we're off on a world tour via radio. Because it's a new SCOTT ALLWAVE DELUXE there'll be no fussing and fumbling about—only one dial to tune, no coils to plug in, no trimmers to adjust carefully. Just use the convenient log furnished with the set and the foreign station you want—maybe 10,000 miles or more away—comes in on the dot.

Let's Start to Merrie England!

Let's try G5SW, Chelmsford, England. Get it any day between 3:00 and 6:00 P.M. Hear peppy dance music from the Hotel Mayfair in London (Yes, those Britishers furnish music that's as "hot" as any orchestra in the States!). Then, too, there are world news broadcasts that tell listeners all over the far-flung British Empire the news of the day in the homeland. At 6:00 P.M. (Midnight London time) it's thrilling to hear "Big Ben," in the House of Parliament, strike the hour of midnight in a sonorous voice.

Foreign Reception Every Day in the Year

Tired of the English program, eh? Like something French? That's easy—let's go to gay Paree.

Here's Radio Colonial, Paris, France, and it is on the air for the SCOTT ALLWAVE DELUXE any day between 3:00 and 6:00 P.M. Hear those dulcet tones of a spirited Mademoiselle? What, you can't understand French? Never mind, here's an orchestra and a song. Music is a universal language. This is Monday—that's lucky, for there'll be an hour's talk in English today about the encampment of the Veterans of Foreign Wars to be held in Paris in 1935.

10,000-Mile Distant Stations Guaranteed

Unusual to get such reception? Not at all for this receiver. This new SCOTT ALLWAVE DELUXE is guaranteed to bring it in like that—yes, absolutely guaranteed to bring in foreign stations 10,000 miles or more away, every day of every week in the year, with loud speaker volume.

How can they make such a guarantee? Well, chiefly because the SCOTT ALLWAVE DELUXE is a custom-made receiver. It is built with as much care and

precision as a fine watch. There's skilled designing and engineering behind it too—as well as parts good enough to carry a five-year guarantee against failure.

Most Perfect Tone Quality in Radio

Want to hear some more? Sure! Where do you want to go? Germany? All right. Here's Zeesen. It can be SCOTT-ed any morning between 9:30 and 11:00. From it you will hear about the grandest symphony concerts put on the air any place. You'll be glad your SCOTT ALLWAVE DELUXE has such exquisite tone. And it is exquisite tone! So perfect that, in a studio test, observers were unable to distinguish between the actual playing of a pianist and the SCOTT reproduction of a piano solo from a broadcasting station when the set and the pianist were concealed behind a curtain.



Tired of Germany? Then let's jump to Spain on our "Magic Carpet." Here's EAQ, Madrid. Hear the castanets and guitars! Always typically Spanish music from this station between 7:00 and 9:00 P.M. You'll enjoy EAQ doubly because they thoughtfully make their announcements in both English and their native tongue.

Opera Direct from the Eternal City

Want a quick trip farther south? Here's Rome—12RO. The lady announcer's voice is saying, "Radio Roma, Napoli." From here, between 3:00 and 6:00 P.M. daily, you'll hear grand opera with its most gorgeous voices and with the finest accompaniments.

So you want to hear what's doing on the other side of the world now? That's easy, let's get up early and pick up VK2ME, from Sydney, Australia, any Sunday morning between 5:00 and 8:30 A.M., or VK3ME, Melbourne, any Wednesday or Saturday morning, between 4:00 and 6:30 A.M. Hear the call of the famous bird of the Antipodes—the Kookaburra. There'll be

an interesting and varied program, music, and always a talk on the scenic or industrial attraction of the country.

Australian Stations Sound Close as Home

Can I get Australia easily? Why, of course you can! In a test didn't one SCOTT ALLWAVE pick up every regular program from VK2ME in Chicago, 9,500 miles away, over a whole year's time? Quite a record! You bet! And what's more, the programs received were recorded on phonograph records, and one was even played back to Australia over long distance telephone, and they heard it clear as a bell! That's performance!

These are but a few of the more than 200 foreign stations that may be heard by SCOTT owners.

Tired of foreign travel? Well, let's jog about the STATES—or Canada or Mexico—on the regular broadcast frequencies. Wonderful? You bet! There was never finer reception. Or you can eavesdrop on police calls, international phone transmission, gabbing amateur wireless telephony fans. Your fun with a SCOTT ALLWAVE DELUXE is unlimited.

New Values! Prices Lowest Ever!

Too expensive for you? Not at all! A SCOTT ALLWAVE DELUXE won't cost you more than any good model of an ordinary receiver. And it gives so much more in pleasure and satisfaction!

You'd like to know more about it—the technical details, and proofs of those wonderful performances? Easy! Just tear out the coupon below, fill in your name and address, and mail it TODAY.

THE E. H. SCOTT RADIO LABORATORIES, INC.
4450 Ravenswood Ave., Dept. N-112, Chicago, Ill.

Tell me how I can have a SCOTT ALLWAVE DELUXE for a "Magic Carpet" of my own, and send me complete technical details, proofs of performance, and complete information.

Name.....
Address.....
City..... State.....

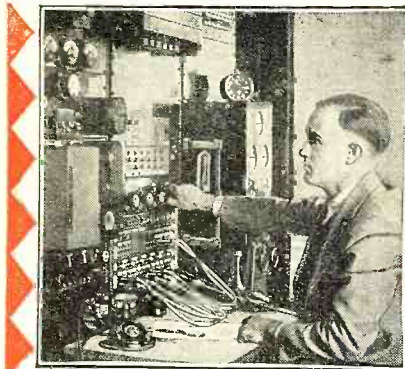

Broadcasting Stations employ trained men continually for jobs paying up to \$5,000 a year.



Police Departments are finding Radio a great aid in their work. Many good jobs have been made in this new field.

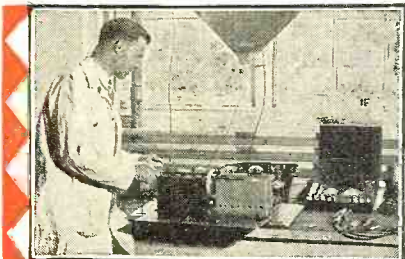

Spare time set servicing pays many N.R.I. men \$200 to \$1,000 a year. Full time men make as much as \$65, \$75, \$100 a week.



Talking Movies—an invention made possible by Radio—employs many well trained radio men for jobs paying \$75 to \$200 a week.



Television—the coming field of many great opportunities—is covered by my course.

I WILL TRAIN YOU AT HOME

Many Make \$50 to \$100 a Week in Radio -- the Field With a Future

My book, "Rich Rewards in Radio," gives you full information on the opportunities in Radio and explains how I can train you quickly to become a Radio Expert through my practical Home Study training. It is free. Clip and mail the coupon NOW. Radio's amazing growth has made hundreds of fine jobs which pay \$50, \$60, \$75, and \$100 a week. Many of these jobs may quickly lead to salaries as high as \$125, \$150, and \$200 a week.

Radio—the Field With a Future

Ever so often a new business is started in this country. You have seen how the men and young men who got into the automobile, motion picture, and other industries when they were started had the first chance at the big jobs—the \$5,000, \$10,000, and \$15,000 a year jobs. Radio offers the same chance that made men rich in those businesses. It has already made many men independent and will make many more wealthy in the future. You will be kicking yourself if you pass up this once-in-a-lifetime opportunity for financial independence.

Many Radio Experts Make \$50 to \$100 a Week

In the short space of a few years 300,000 Radio jobs have been created, and thousands more will be made by its future development. Men with the right training—the kind of training I will give you in the N.R.I. Course—have stepped into Radio at 2 and 3 times their former salaries. Experienced service men as well as beginners praise N.R.I. training for what it has done for them.

Many Make \$5, \$10, \$15 a Week Extra in Spare Time Almost At Once

My Course is world-famous as the one "that pays for itself." The day you enroll I send you material, which you should master quickly; for doing 28 Radio jobs common in most every neighborhood. Throughout your Course I will show you how to do other repair and service jobs on the side for extra money. I will not only show you how to do the jobs but how to get them. I'll give you the plans and ideas that have made \$200 to \$1,000 a year for N.R.I. men in their spare time. G. W. Page, 110 Raleigh Apts., Nashville, Tenn., writes: "I made \$935 in my spare time while taking your Course." My book, "Rich Rewards in Radio," gives many letters from students who earned four, five, and six times their tuition fees before they graduated.

Get Ready Now for Jobs Like These

Broadcasting stations use engineers, operators, station managers and pay up to \$5,000 a year. Radio manufacturers employ testers, inspectors, foremen, engineers, service men, buyers, and managers for jobs paying up to \$6,000 a year. Radio dealers and jobbers (there are over 35,000) employ service men, salesmen, buyers, managers and pay up to \$100 a week. Talking pictures pay as much as \$75 to \$200 a week to men with Radio training. There are hundreds of opportunities for you to have a spare time or full time Radio business of your own—to be your own boss. I'll show you how to start your own business with practically no capital—how to do it on money made in spare time while learning. My book tells you of other opportunities. Be sure to get in at once. Just clip and mail the coupon.

I HAVE STARTED MANY IN RADIO AT 2 AND 3 TIMES



**\$400
Each
Month**



**\$800
In Spare
Time**



**Chief Engineer
Station
WOS**

"I spent fifteen years as traveling salesman and was making good money but could see the opportunities in Radio. Believe me I am not sorry, for I have made more money than ever before. I have made more than \$400 each month and it really was your course that brought me to this. I can't say too much for N.R.I." J. G. Dahlstead, Radio Station KYA, San Francisco, Cal.

"Money could not pay for what I got out of your course. I did not know a single thing about Radio before I enrolled, but I have made \$800 in my spare time although my work keeps me away from home from 6:00 A.M. to 7:00 P.M. Every word I ever read about your course I have found true." Milton I. Leiby, Jr., Topp, Pa.

"I have a nice position and am getting a good salary as Chief Engineer of Radio Station WOS. Before entering Radio, my salary was barely \$1,000.00 a year. It is now \$2,400.00 a year. Before entering Radio, my work was, more or less, a drudgery—it is now a pleasure. All of this is the result of the N.R.I. training and study. You got me my first important position." H. H. Lance, Radio Station WOS, Jefferson City, Mo.

TO BE A RADIO EXPERT



Act Now - - - Mail Coupon Below for Free Book of Facts and Proof

You Learn at Home in your Spare Time to be a Radio Expert

Hold your job. There is no need for you to leave home. I will train you quickly and inexpensively during your spare time. You don't have to be a high school or college graduate. My Course is written in a clear, interesting style that most anyone can grasp. I give you practical experience under my 50-50 method of training—one-half from lesson books and one-half from practical experiments with equipment given without extra charge. This unique and unequalled method has been called one of the greatest developments in correspondence Radio training. N.R.I. pioneered and developed it. It makes learning at home easy, fascinating, practical.

Learn the Secrets of Short Wave, Television, Talking Pictures, Set Servicing, Broadcasting, Etc.

I'll give you more training than you need to get a job—I'll give you your choice, and not charge you extra either, of my Advanced Courses on these subjects—(1) Television, (2) Set Servicing and Merchandising, (3) Sound Pictures and Public Address Systems, (4) Broadcasting, Commercial and Ship Radio Stations, (5) Aircraft Radio. Advanced specialized training like this gives you a decided advantage.

Your Money Back If You are Not Satisfied

I will give you an agreement in writing, legal and binding upon this Institute, to refund every penny of your money upon completing my Course if you are not satisfied with my Lessons and Instruction Service. The resources of the National Radio Institute, Pioneer and World's Largest Home-Study Radio School stands behind this agreement.

Find out what Radio offers. Get my Book

One copy of my valuable 64-page book, "Rich Rewards in Radio," is free to any resident of the U. S. and Canada over 15 years old. It has started hundreds of men and young men on the road to better jobs and a bright future. It has shown hundreds of men who were in blind alley jobs, how to get into easier, more fascinating, better paying work. It tells you where the good Radio jobs are, what they pay, how you can quickly and easily fit yourself to be a Radio Expert. The Coupon will bring you a copy free. Send it at once. Your request does not obligate you in any way. **ACT NOW.**

J. E. SMITH, President
 Dept. 2MR, National Radio Institute
 WASHINGTON, D. C.

FORMER PAY



Experienced Radio Man Praises N. R. I. Course

"Before taking your course, I had worked at Radio for over seven years, doing quite a bit of servicing, but I realized that I was in need of better training. From the first lesson on I began to understand points that had had me wondering. I would not take many times the price it has cost me, for the knowledge I have gained. In a period of nine months, I have made at least \$3,500." C. J. Stegner, 28 So. Sandusky St., Delaware, Ohio.

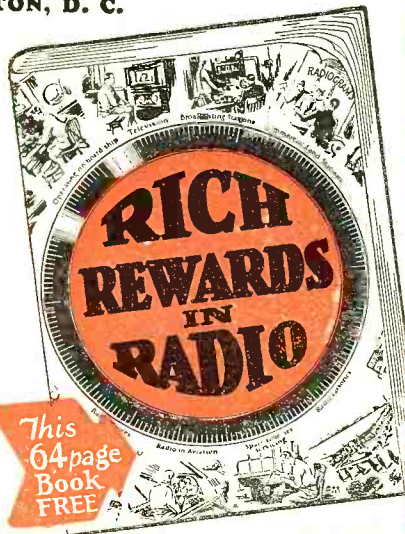

Special FREE Offer

Act now and receive in addition to my big free book, "Rich Rewards in Radio," this Service Manual on D.C., A.C., and Battery operated sets. Only my students could have this book in the past. Now readers of this magazine who mail the coupon will receive it free. Overcoming hum, noises of all kinds, fading signals, broad tuning, howls and oscillations, poor distance reception, distorted or muffled signals, poor Audio and Radio Frequency amplification and other vital information is contained in it. Get a free copy by mailing the coupon below.

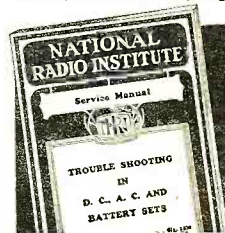

SPECIAL Radio Equipment for Broad Practical Experience Given Without Extra Charge

My Course is not all theory. I'll show you how to use my special Radio equipment for conducting experiments and building circuits which illustrate important principles used in such well-known sets as Westinghouse, General Electric, Philco, R. C. Ac, Victor, Marzoc, and others. You work out with your own hands many of the things you read in our lesson books. This 50-50 method of training makes learning at home easy, interesting, fascinating, intensely practical. You learn how sets work, why they work, how to make them work when they are out of order. Training like this shows up in your job envelope—when you graduate you have had training and experience—you're not simply looking for a job where you can get experience.

With N. R. I. equipment you learn to build and thoroughly understand set testing equipment—you can use N. R. I. equipment in your spare time service work for extra money.

Clip and mail NOW for FREE INFORMATION

J. E. SMITH, President
 National Radio Institute, Dept. 2MR,
 Washington, D. C.

Dear Mr. Smith: I want to take advantage of your Special Offer. Send me your Service Manual "Trouble Shooting in D.C., A.C. & Battery Sets" and your book "Rich Rewards in Radio," which points out the opportunities for spare time and full time jobs in Radio and your famous 50-50 method of training men to become Radio Experts through home study. I understand this request does not obligate me.

Name.....
 Address.....
 City..... State.....

"M"

The Editor—to You

RADIO is recognized this year for its importance both to the voter and the candidate for office in the November elections and leading up to them.

* * *

"THE law provides that if a broadcaster permits one candidate to use his facilities equal opportunity must be offered to all other candidates for that office," Harold A. La Fount, acting chairman of the Federal Radio Commission, said recently. . . . "The broadcaster, under the law, has no right of censorship over the material broadcast by political candidates other than to see that no obscene, indecent, profane or defamatory language is used." . . . "Broadcasters have a wonderful opportunity in the present campaigns for public office to render a distinct and outstanding public service. They have a rare chance to develop good-will and to popularize their stations by providing a forum whereby candidates can freely and fully discuss paramount issues." . . . "Of course all of our people are vitally interested in the election of a president, members of Congress, governors of many states and other leading officials. Radio stations should prove a big factor in transmitting speeches, calculated to inform voters and to qualify them to vote intelligently." . . . "Dispassionate discussion of public questions by candidates, in my judgment, will have a wholesome effect on listeners, arousing their interest in governmental affairs and public questions. The transmission of such intelligence to our people should prove most stimulating and add to the cultural progress of the nations by keeping the electorate fully informed on public matters."

* * *

THAT the radio campaigns as well as the candidates themselves intend to use radio in this way is shown by the following representative quotation:

"Radio is to play an important part in the coming campaign," said James A. Farley, Chairman, Democratic National Committee, in an exclusive interview to RADIO NEWS Magazine. "Of the many sources of comfort and pleasure which science has given us, Radio appears to hold first place. Politics, music, speeches and all sorts of entertainment is given us at practically no cost. Radio contributes one of the great educational forces in existence today. What would we do without the intimate knowledge which before the advent of Radio was obtained by second-hand information? Yes, I repeat, that Radio is one of the greatest achievements of science and it is one which we are going to use throughout the remainder of our campaign."

* * *

AS WELL as in national politics, the in-

ternational political systems are beginning to realize the importance of radio as a means of quick communication. The two photographs on this page show the League of Nations' wireless station at Geneva, Switzerland, recently placed in service. One illustration shows the interior view of the transmitting equipment while the other shows the huge towers that are, it is said, to be used in sending messages of world-wide import to every locality on earth and receiving messages, likewise, from any spot.

* * *

OUR lead article this month considers the importance of radio to the American citizen as a voter and tells him

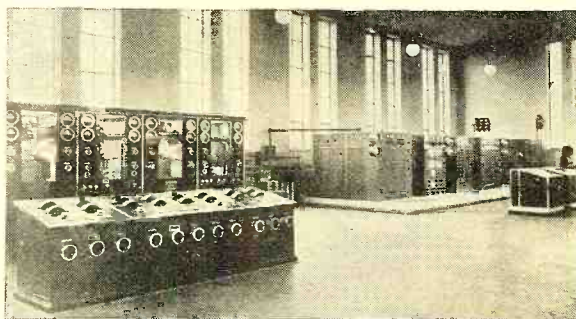
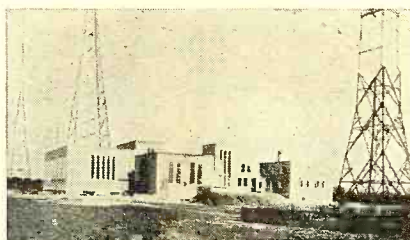

how to make the most out of this medium in information that will enable him to vote intelligently.

* * *

AND that brings us also to the door of the serviceman. Here is an opportunity of great potentiality for the radio serviceman to show the stuff he is made of and at the same time earn a profit that should be considerable even in these times of depression. Every voter will want to have his receiver in good condition and servicemen are the right people to do this job.

* * *

THE use of public address systems, expensive ones for large political gatherings and low-priced affairs for small clubs, etc., is featured in two articles in this issue and servicemen will find in these an opportunity to cash in on this month's growing political activities.

* * *

COMING over the editor's desk are many letters of suggestion and comment, a few of which follow below:

"I shall take this opportunity to say that while I buy three other leading radio magazines, I believe RADIO NEWS is the best on the market. I have every copy received on file and value them as a higher course in radio training. I am using several business getters from your Service Bench department and they sure help a lot. I would like to see a compact radio course in monthly installments appear in RADIO NEWS."—William S. Wood, Hatch, N. Mex.

* * *

"WOULD all the readers of RADIO NEWS who are interested in radio telegraphy correspond with me at 193 Avoniel Road, Belfast, Ireland."—William Elliott.

* * *

"JUST penning these few lines to let you know that your publication is very much appreciated down under. I always look forward to the next copy. The new idea you have started, the DX'ers Corner, is, I think, a really good idea and will be received favorably by the majority of your readers."—Kenneth H. Moffatt, New Zealand DX Club, Auckland, N. Z.

* * *

"JUST a word from a reader who would like to see more of John Borst's articles in your magazine. His articles are always of vital interest, generally what I am looking for."—Carlyle W. Satterlie, Meadville, Pa.

* * *

"WHAT happened to the 'What Tube Shall I Use?' articles by Mr. Calcaterra. Please resume the publication of this series."—Willis Emery, Salt Lake City, U.

* * *

"I DARE say you receive quite a bunch of letters from foreign readers of your journal. In my particular line I have found the "News" about the most interesting radio book possible to obtain. Down here in Australia a very strange thing about radio is that, although this is a British country, English ideas in radio, tubes, etc. (valves, as the English call them), are used hardly at all. There is about only one set in a hundred that uses English tubes. All the balance consists of Yankee tubes."—Geo. E. Shaw, Melbourne, Victoria, Australia.

* * *

"I AM a licensed radio telegraph and telephone first-class operator, but at the present time am working servicing radio receivers. I am a newsstand purchaser of RADIO NEWS and think it cannot be beat."—W. B. Kolho, Sumner, Nebraska.

Stewart M. Lockaday

NATIONAL SW-58 THRILL-BOX
'ROUND THE WORLD --- FIRST CLASS!
CONTROLLED SELECTIVITY"
RANGE 9-850 METERS
NEW ISOLATION
NEW 58 TUBES INCREASE GAIN AND SELECTIVITY
STANDARD SET OF COILS NOW COVERS RANGE 15 TO 900 METERS. ADDITIONAL COILS AVAILABLE FOR HIGHER AND LOWER FREQUENCIES
ROTOR GANG CONDENSER
VELVET VERNIER DIAL
OPERATES ON A. C.
COMPLETE ISOLATION BETWEEN CIRCUITS
USED BY POLICE, U.S. GOVT., SHIP REPORTS, EXPEDITIONS, AIRWAYS, PHONO JACK
LOUD SPEAKER EVERYWHERE

4 YEARS NEW!

NATIONAL SW-58 Thrill Box is four years NEW. Four years ago short-wave broadcast listeners heard around the world with NATIONAL Thrill Boxes. Each year, with new and better tubes and new and better research, the Thrill Box has been improved . . . now the SW-58 Thrill Box offers features to the users not dreamed of in September 1928. "Controlled Selectivity," an entirely new order of isolation between circuits, tremendous RF gain with the new 58 tubes . . . and during four years, a constant stream of *unsolicited, unpaid for*, enthusiastic testimonials from users who PAID for their NATIONAL Receivers, have flowed in praising the performance of the Thrill Box.

"In two months I have logged nearly 1000 stations which includes about forty foreign countries."
 Centralia, Washington.

"I would like to tell you that the Thrill Box is absolutely the best short-wave set I have heard, regardless of price. I have received stations in Australia, Holland, England, Germany, South America, Central America, all on the loud speaker . . ."
 San Antonio, Tex.

"I am tuning in stations from all over the world . . ."
 Malvern, Pa.

"I have had the receiver in operation for about a month and wouldn't trade it for any six others I have ever heard . . ."
 Fairport Harbor, Ohio.

Takes a Whiskey and Soda in Sweden

"Apart from listening clearly every night to 2XAF on 31, 48 meters and other American stations on 79 meters, I have had both F.2k Saigon, and VK2ME Australia on the speaker with volume enough to fill the house. No distance is too great for my 'box'. I am proud of my NATIONAL and take a real whiskey and soda in honor of the best short-wave set in the world."
 Trillhattan, Sweden.

Names on Request

When You Buy the NATIONAL SW-58 Thrill Box You Get

Utmost Sensitivity, Extremely Low Background Noise (highest signal-to-noise ratio), Unequaled Flexibility and Ease of Control.

"Controlled Selectivity." An entirely new feature, found only in the SW-58, which allows the set always to be operated at the best selectivity consistent with signal strength and reception conditions.

Loud Speaker Performance. A Push Pull Stage with 245 tubes for best tone-quality gives fine loud-speaker volume. There is also a jack for headphones.

Full AC or DC. The AC set operates with the NATIONAL 5880 Special SW Power Supply with extra shielding and filter sections for humless operation. RCA Licensed. Battery model also available for use where there is no AC current.

New 16-Page Catalogue and Full Particulars Without Obligation. Mail the coupon below today for your copy of our new 16-page catalogue and full details of the new NATIONAL SW-58 THRILL BOX.



NATIONAL SW-58 THRILL-BOX

REGULAR USERS of NATIONAL Short-Wave Equipment

NATIONAL Short-Wave Equipment and Short-Wave Receivers are used by thousands of Short-Wave listeners and amateurs all over the world, and by every large commercial company in the communications field, including:

- | | |
|-------------------------------------|--|
| General Electric Co. | Signal Corps, U. S. Army |
| Westinghouse Electric & Mfg. Co. | U. S. Dept. of Commerce (Lighthouse Service) |
| R.C.A. Communications | Pan American Airways |
| Tropical Radio (United Fruit Co.) | Boeing Air Lines |
| Federal Tel. & Tel. Co. | Western Air Express |
| Western Electric Co. Press-Wireless | Transcontinental and Western Air Express |
| Maekay Radio (Postal) | Radio-Marine |
| American Airways | United Air Lines |
| American Tel. & Tel. Co. | Eastern Air Transport |
| Canadian Marconi | Canadian Airways, Ltd. |
| U. S. Naval Research Laboratories | Southern Air Transport |
| U. S. Navy | |

NATIONAL A. C. SW-58 THRILL-BOX



NATIONAL CO., INC.
 61 Sherman Street, Malden, Mass.

Please send me your new 16-page catalogue and full information on the NATIONAL AC SW-58 THRILL BOX.

Name

Address

RN 11-32.

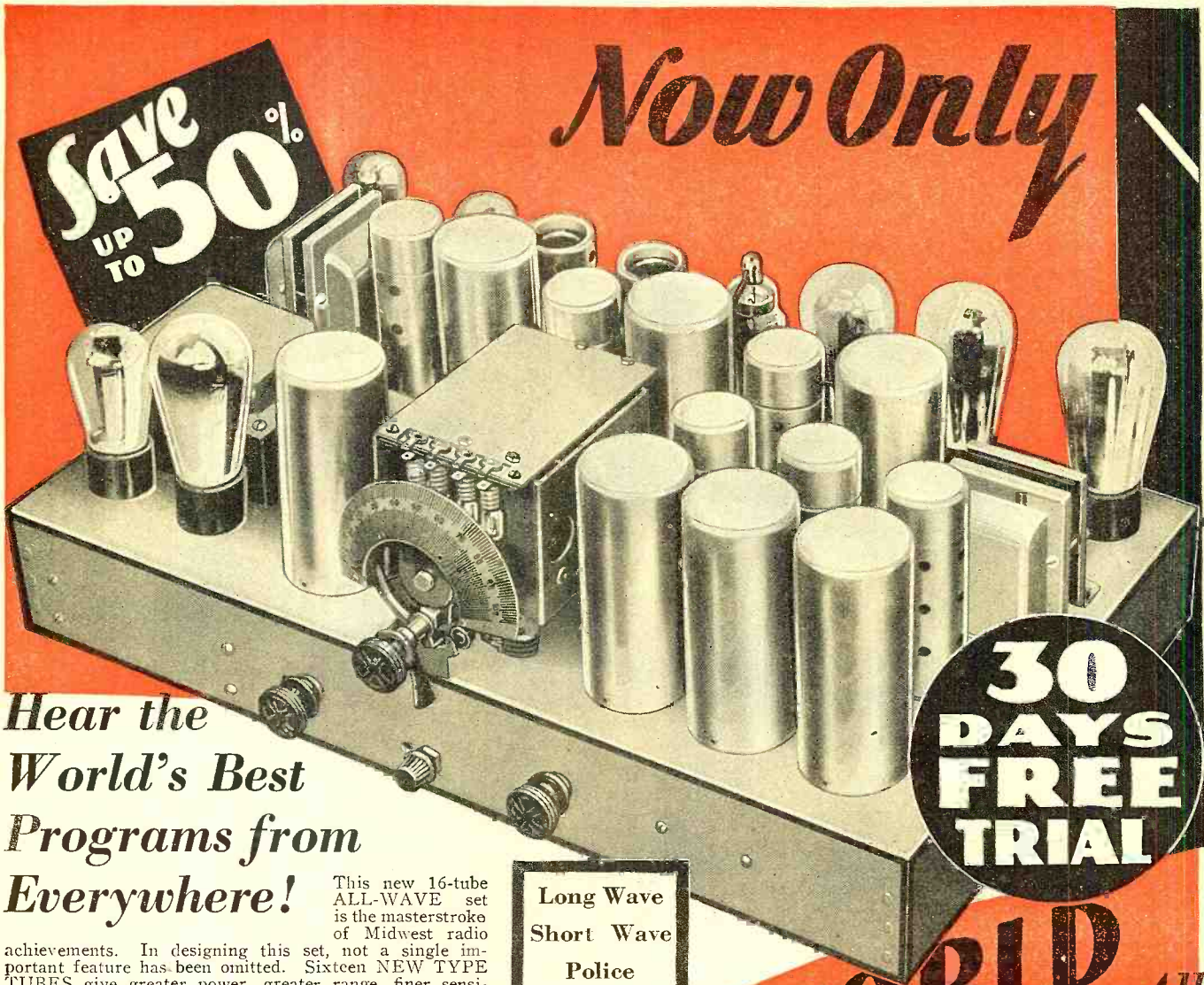

**Hear the
World's Best
Programs from
Everywhere!**

This new 16-tube ALL-WAVE set is the masterstroke of Midwest radio achievements. In designing this set, not a single important feature has been omitted. Sixteen NEW TYPE TUBES give greater power, greater range, finer sensitivity, amazing selectivity which assures performance unequalled by any radio regardless of cost.

No extra dial—no short-wave converter—no trimmers or auxiliary units of any kind. One big, complete chassis with all the new refinements and improvements that make Midwest 1933 Radios miles ahead of the best sets ever produced.

Remember, this is an ALL-WAVE set, giving you not only U. S. broadcasts, but Police, Airplanes, Ships at Sea and, under favorable conditions, foreign Short Waves—the **WHOLE WORLD** of radio with one set, controlled by one dial. Think of the pleasure of tuning in London, Paris, Berlin, Rome, Havana, Mexico City, Sydney, Australia, and many other stations all around the world.

Don't buy any radio until you get all the facts about this Midwest 16-Tube marvel which is sold direct from the factory, saving you 30% to 50%. Mail the coupon on opposite page, or write us a postal.

Long Wave
Short Wave
Police
Amateur

**30
DAYS
FREE
TRIAL**

'ROUND-THE-WORLD All
The New
1933 Features

- Stat-Omit Tuning Silencer
- Class "B" Amplification
- Color-Lite Wave Band Selector
- Acoustically Matched Dual Speakers
- Full Band Automatic Volume Control
- Dual Power—Two separate transformers
- Dual Ratio Dial
- New Type Tubes
- 7½ K. C. Selectivity
- Complete Scientific Shielding
- 18 Tuned Circuits, 9 in cascade
- 15 to 550 Meter Tuning Range
- Image Frequency Suppressor
- Fractional Microvolt Sensitivity
- Full-Floating Variable Condenser
- True Tone Reproduction
- Improved Super-Heterodyne Circuit
- Positive Tone Control
- Thermal Safety Fuse
- Duo Diode Detection
- Low Operating Cost

Nothing has been overlooked and nothing important omitted in the new Midwest 16-tube ALL-WAVE A. C. sets. You'll be amazed and delighted with the volume, the ease of control, the amazing clarity of reproduction and the absence of frying and cracking noises. Such radio reception has never before been known. This 16-tube set positively offers more features, more improvements, more refinements than sets selling in retail stores at two to three times Midwest's low factory prices. Don't buy a set of any kind until you get the big new Midwest catalog. Mail the coupon now. Learn how you can save 30% to 50% direct from the factory—and buy on easy terms to suit your convenience.

MIDWEST RADIO CORP.

\$39⁹⁵

Completely Assembled with Large Dual Speakers

New
16-TUBE
All-Wave
15 to 550 Meters

Complete Line of New Consoles

The big new Midwest catalog shows gorgeous line of artistic consoles in the new six-leg designs. Mail the coupon now. Get all the facts. Learn how you can save 30% to 50% on a big, powerful radio by ordering direct from the factory.

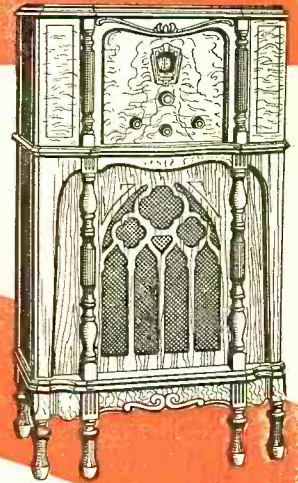

RECEPTION!

TERMS
 as low as
\$5.00
DOWN

30 Days FREE TRIAL, right in your own home, assures you complete satisfaction. Thousands upon thousands of delighted Midwest owners all over the U. S. are daily enjoying the world's finest radio programs because of Midwest's revolutionary policy of selling direct from the factory at bed-rock prices—and on easy terms. But don't judge quality by price. Even tho we offer unbelievably low prices Midwest Radios are of the very highest quality and positively guaranteed. Furthermore, we back our guarantee with 30 DAYS FREE TRIAL right in your own home. When you buy from Midwest you deal with one of the old-established pioneer radio builders who have been selling quality sets all over the world for more than twelve years. Mail the coupon or write us a postal for new 1933 catalog, easy terms and low factory prices.

Deal Direct With Factory!

Don't be satisfied with less than a Midwest 16-tube A. C. radio. A receiver covering only the regular broadcast waves is only half a set. Improvements in short-wave programs have made ordinary broadcast sets obsolete. The Midwest gives you regular, foreign, police and amateur broadcasts—both long and short wave—in one single dial set. No converter or any extra units required.

SAVE
 UP TO
50%

Investigate! Mail the Coupon!

Get the Midwest catalog. Learn the facts about Midwest 9, 12 and 16-tube ALL-WAVE sets—also Battery sets and amazing new Automatic Record-changing Radio Phonograph. Learn about our sensationally low factory prices, easy payment plan and positive guarantee of satisfaction or money back.

Dept. 129, CINCINNATI, OHIO
 (Est. 1920)

Read this letter!

"During the past week I logged the following: FYA Pontoise, France; GBK Rugby, England; HVJ Vatican City, Italy; XDA Mexico City; VK2ME Sydney, Australia; VE9GW Bowmanville, Canada; 12RO, Rome, Italy; G5SW Chelmsford, England; CGA and VE3DR Drummondville, Canada. Also picked up many amateur and airport stations from all over United States. Numerous ship, shore and transatlantic phones from both sides and an Hawaiian Test Station came in clear and sharp. Several Spanish and German speaking stations have also been received but not yet identified. Have received every broadcast from FYA, morning and afternoon, for over a week with wonderful tone and volume. The Midwest set is certainly one to be proud of." Wm. S. Teter, Winterpark Florida.

Get All the Facts NOW

RUSH THIS COUPON FOR AMAZING FREE TRIAL OFFER AND BIG BEAUTIFUL CATALOG

Midwest Radio Corp., Dept. 129, Cincinnati, Ohio. Gentlemen: Please rush my copy of your big, beautiful, new catalog and complete details about the powerful, new 9, 12, and 16-Tube ALL-WAVE super-heterodyne outfits. I am not obligated.

USER AGENTS
 Big money in spare time. Check here for details.

Name Street Town State



Radio Ears in High Places

Through the installation of the broadcasting microphone at great political conventions, the voting public may now listen to the proposals or pleas made by party delegates. Candidates for office, when chosen, can also speak directly to the voter through this medium and thus make direct contact with millions of potential votes that will either place him in or keep him out of office. No longer need the voting public remain in ignorance of political platforms or personalities of the candidates through which their own political hopes and wishes may be realized. For radio, today, is enabling the voter to sit in and observe what his delegates are doing for him.

Radio News

VOLUME XIV

November, 1932

NUMBER 5

RADIO AIDS THE VOTER

This is the period that calls for an intelligent vote if our government is to give us in the coming four years a sound foundation on which to rebuild our future economic structure. And radio, as no other medium in the past, offers the individual voter what is now considered the best way to decide intelligently how he will vote

THE 1932 presidential election is looming as the hardest-fought battle in the history of modern politics. It is expected to call out more voters and more intelligent voting than has ever been witnessed in the life of the country. One of the main reasons for this is found in the economic period through which we are now passing. The individual voter has been awakened—he is voting for his own economic life and the future of his family. He is voting this year with all his intelligence. He is earnestly trying to understand the principles of government that must be installed or continued in force during the next four years (especially in the immediate future) to lift the veil of depression and to start the economic path upward. He is voting this year to restore business courage and to discourage that headlong fear which has been so serious a factor in extending the depression.

Another important feature that is to insure a large roll-call on Election Day is the growing importance of radio broadcasting in politics. Radio has tended to make the American citizen "campaign conscious" and is now considered the leading means for contact between candidate and the individual voter who is to support them or

By Laurence M. Cockaday

perhaps defeat them at the polls.

Still another important factor is the fact that, although women in

general *do not* read political articles, they *do listen* to political speeches over the radio.

What has radio to offer this year to the conscientious individual voter? What has it to offer to the voter that no other medium in the world can provide? It is this: A direct personal method by means of which every voter can be said to be "face to face" and listening without interruption to the candidate's appeal for his individual vote based upon a personal promise of a definite plan of action, if elected. The voter today may sit at home, comfortably surrounded by his

family and with nothing to interrupt his contact with the candidates he is thus investigating. Radio has installed the voter as the highest Court of Appeal for the first time in history. Radio is thus contributing to the principles of true democracy, long hidden and replaced by excitement, by oration, by mob appeal and by circus ballyhoo. In campaigning by Radio, the voter no longer need be swayed unconsciously by these psychological forces that delude, that cajole, that prejudice and that tend to "pull the wool over his eyes." He listens to the

"Radio Is Mightier Than the Pen or the Sword"





Franklin D. Roosevelt

1932 DEMOCRATIC PRESIDENTIAL CANDIDATE

"IN olden days, campaigns were conducted amid surroundings of brass bands and red lights. Oratory was an appeal primarily to the emotions and sometimes to the passions. It always has been my feeling that, with the spread of education, with the wider reading of newspapers and especially with the advent of the RADIO, mere oratory and mere emotion are having less to do with the determination of public questions under our representative system of government. Today common sense plays the greater part and final opinions are arrived at in the quiet of the home."

candidate in his own court—he judges—and his decision is his own! The candidate, on the other hand, must stand on his own feet and be judged by his own past and his own plans for the future as expressed via radio. The microphone is thus to be mightier than the pen or the sword.

It is not my purpose, in this short article, to tell you how to vote; it would not be my thought to let any trace of my own personal feelings show in this text. But it is my duty to tell you how you may use Radio as an aid to making an intelligent vote.

You voters, who have a definite patriotic duty to perform and who feel an urgent demand to place or continue in power the best principles of government for these times, will do well to make Radio your principal means for gathering the necessary data for a sincere voting decision. The statements of the candidates on these pages agree with me, I think, that such is the case.

HOW CONVENTION BROADCASTS ARE ACCOMPLISHED

A broadcasting booth set up in Chicago for the broadcasting facilities in the 1932 party conventions

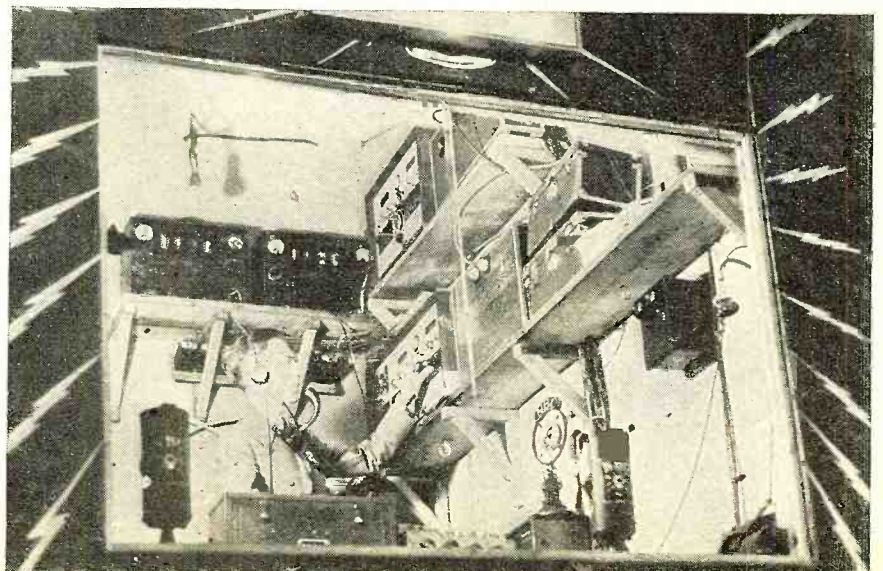

I do not mean to say that Radio is the only medium available at the hands of our citizenry by which the necessary information regarding candidates and their fitness can be arrived at. There are, of course, the home magazines, which contain, from time to time, excellent articles by the candidates or about the candidates which may be of value.

And then there is the local Political Club, with its meetings, its speeches and rallies. There are also a number of Mass Meetings at which the local and national candidates and other speakers set forth their platforms, views and plans.

Then again, the Newspapers contain, during periods such as this, vast amounts of political material from a candidate, a party and a local aspect, as well as listing programs of a political nature occurring on the various local radio stations.

Radio Plays No Favorites

But in these mediums there are sometimes found great opportunities for prejudice, for policy, etc., to permit a shading of the facts, a rounding out of the picture toward one particular viewpoint. The Magazine may have its own political policy; it therefore may not present all the candidates and political principles in a favorable light. It may tell a half-story. The Political Club usually colors its rallies to suit the Party policy, placing halos on the heads of its own candidates and damning the opposition without much regard for personal abilities. Newspapers usually have their own political hopes and aspirations, and you can often read one, on one side, and change the names of the candidates and you have what the other newspaper may say about its opponents.

However, Radio belongs (in America) to no particular political group. The Government has established it as a service to its citizenry which allows of neither partisanship nor prejudice. Any Party candidate may use Radio and say what he likes, providing he pays for the broadcasting time. The broadcasting facilities have no political aspirations one way or another, and that is as it should be. The candidate, speaking by Radio, speaks for himself and for the principles he sets himself the task to uphold. His language is his own language, and before the individual listener, who is a potential voter, he stands or falls by his own words, minus the ballyhoo, the excitement and the dressing-up of other mass

meetings with voters.

And, do you know, it would take more than a good actor to stand before a microphone, realizing one is speaking directly to the individual who is to vote for or against you, making

insincere or demagogic utterances without the fear of becoming "found out" showing in one's tone of voice. There are many things that have been said on street corners, during past campaigns, that even the most brazen political speaker would not dare to utter before a microphone when he knows the whole world is listening. So the old order of ballyhoo is "out" and a new order of political campaigns, by Radio, giving facts that can be proven and proposing governmental measures that will bear investigation, is "in."

As evidence that campaigners of all parties believe in this new order of things is the fact that radio broadcasting is now considered the chief item of expense by the leading parties.

I am listing below a number of things it is important that the voter attend to this year as a patriotic duty, in order to cast an intelligently planned ballot, using Radio to its fullest extent:

Hints for Radio's Voters

1. If you have no radio receiver, purchase a good one and have it installed immediately in your home for the remainder of the campaign.

2. If you already have an old radio receiver, in anything but the finest working condition, get it repaired at once and put it in first-class working condition. Your local serviceman can do this for you economically and efficiently.

3. Consult the program lists in the newspapers for campaign and make it a point to be at home with the other voters of your family when these political events are on the air at the appointed hours. Have perfect quiet maintained throughout the hour.

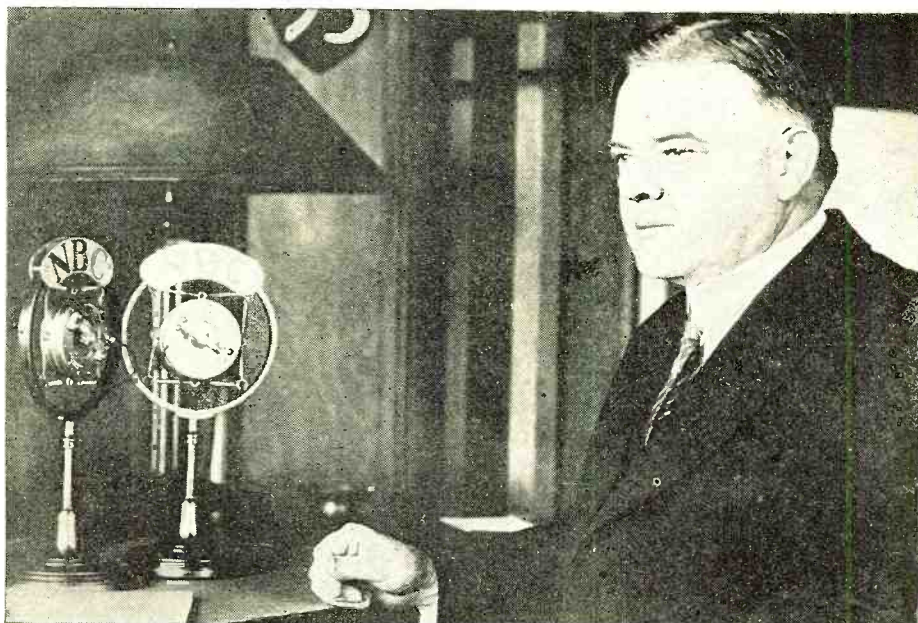

Herbert C. Hoover

1932 REPUBLICAN PRESIDENTIAL CANDIDATE

"THE determination that radio channels were public property and should be controlled by the government; the determination that we should not have governmental broadcasting supported by a tax upon the listener . . . has secured for us far greater variety of programs and excellence of service without cost to the listener. This decision has avoided the pitfalls of political and social conflicts in the use of speech over the RADIO which would have been involved in government broadcasting. It has preserved free speech to the country.

"These principles are now strongly imbedded in our law and in our entire public system. . . . It is needless to mention the many-sided importance of RADIO in modern life. Its dissemination of entertainment, of knowledge, of public opinions, and topics of the public welfare, has become an essential element in the intellectual development of our country."

4. Listen in carefully and make notes on the outstanding features you like or dislike regarding the candidates or their proposals.

5. Discuss the features you are in doubt about, with your family and friends.

6. Check up on any broadcast statements you question, at your local political headquarters.

7. Get up and vote early on Election Day with a clear conscience and the feeling that you have done everything at your command to help America and yourself to a more prosperous future.

And while giving this advice on using radio in determining your vote, it might be advantageous to also list a number of important considerations that the candidate and campaign speaker should take into account in using radio for political canvassing. A few of these items are set down (*Continued on page 295*)



Norman D. Thomas

1932 SOCIALIST PRESIDENTIAL CANDIDATE

"WHETHER or not RADIO is an advantage or a disadvantage to the campaigner, its existence makes it a fact to be reckoned with. It is, on the whole, an advantage both to the campaigner and to the public. . . . Radio speaking tends somewhat to cut out the element of 'bunk' in political speeches. . . . Obviously it enables a very much larger audience to hear a candidate and what he says. Properly managed, RADIO should be an asset to democracy."

TELEVISION

ON ONE

Revolutionary method for casting on a single transmitter and bined wave on a single receiver living pictures side by side

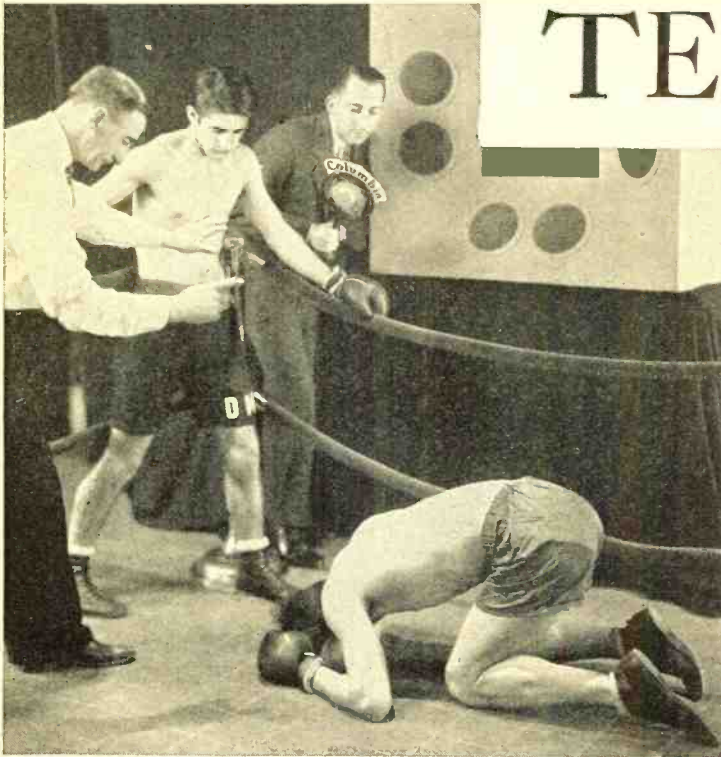

ONE OF THE FIRST "COMPLETE" BROADCASTS

A boxing bout presented before the electric eyes of the new combination transmitter developed by Columbia engineers

By Samuel Kaufman

THE inauguration, recently, of a new method of transmitting moving images and synchronized sound over a single station and on a single channel, by the Columbia Broadcasting System, is appropriately timed for the first anniversary of the network's entrance into the television field.

In addition to representing an important advancement in sight-and-sound transmission methods, the CBS system called for a new system of reception. Network engineers offered the public a plan whereby a single television receiver, with certain economical modifications, could be made to successfully receive both the picture and the synchronized sound. This plan was limited only to certain television receivers yielding a high enough frequency response to adequately reproduce the sound portion of the programs.

In the Summer of 1931, the Columbia System stirred up considerable interest in the field of television by launching a "sight" transmitter, W2XAB, in New York City, and presenting regularly scheduled daily programs. A large number of the television broadcasts during the first year of the transmitter's operation were presented with synchronized sound programs from the network's short-wave station W2XE. As in the instance of all other television stations in the United States during this period, this television station was licensed by the Federal Radio Commission as an "experimental" transmitter. Regardless of what method of reception is used, the new system, in the opinion of William A. Schudt,

Jr., television director of the network, will be of great value to the radio audience.

"When we broadcast pictures and sound on separate transmitters," Schudt remarked to the writer, "it was discovered, through mail from all parts of the country, that some persons received the television portion of the synchronized programs very clearly but had difficulty in locating the sound station. Likewise, there were some persons who obtained the sound but not the picture. By having sight-and-sound on *one* transmitter, every person who succeeds in tuning in the picture will be assured of getting the sound along with it.

"Under the old method, the transmissions of W2XAB were successfully received, according to fan mail, over a 2,000-mile distance from New York. Two-thirds of the United States has been covered by our picture programs. There is every indication that our new method of sight-and-sound broadcasts on a single wavelength reach over this same area.

"I believe that the sound portion of the programs will penetrate farther than the television part of the presentations. This is due to the fact that the sound takes the air directly, while the images must first be converted into sound impulses at the transmitter end and later be reconstructed into images."

The CBS has applied to the Federal Radio Commission for an additional channel in the ultra-short-wave band for future expansion of the network's television system. When officially granted, it is the plan of the CBS to use the added wavelength for the simultaneous broadcasting of the same sight-and-sound programs as on W2XAB.

"The Columbia television development is a great step in the advancement of television," the networks television director declared. "Television is not around the corner. It is already here and has been here for over a year!"

Network engineers working under E. K. Cohan, technical director of the CBS, were so satisfied with the advanced ex-

COMPLEX WAVE

FIGURE 1

Television signals modulate the main carrier with side bands of 38 kc. A 45 kc. carrier carrying 5 kc. sound side bands also modulates the main carrier for television

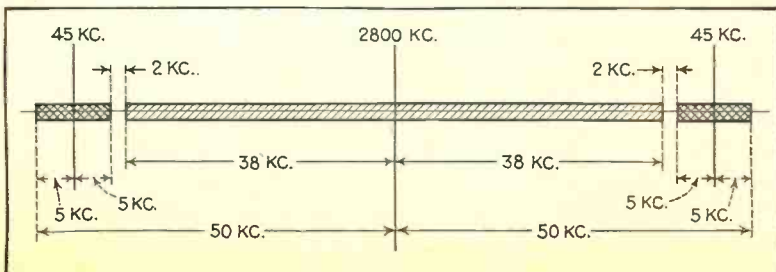

AND SOUND

WAVE!

*transmitting sight and sound broad-
for picking up the resultant com-
that demodulates and produces the
with the broadcast sounds*

periments that a two-hour sight-and-sound broadcasting schedule each day, excepting Saturday and Sunday, was put into effect at the time of the system's inception in July.

CBS engineers acknowledge the fact that sight-and-sound broadcasting on one wavelength has long been a field of study for research engineers and that the goal has previously been achieved in laboratories. Nevertheless, it is believed that the CBS, through its New York transmitter, is the first broadcasting firm to utilize this method regularly.

It was necessary to close down W2XAB for a two-week period to make the necessary modifications in the transmitter to accommodate sound in addition to images.

William B. Lodge, development engineer of the network who was assigned to the project, asserted that "double modulation" is the term which best describes the principle of the system. He explained that when the user of a radio set tunes his receiver to a broadcasting station, he is tuning to the particular carrier frequency of that station. The signal which reaches the set from the antenna consists of this carrier frequency combined with the frequencies of speech or music. Thus, he explained, the receiver has the ability to separate the speech or music from this complex wave and to reproduce it in the loudspeaker. The carrier is said to be *modulated* by the audio signal.

The Fundamental Principle

Lodge asserted that the first step in the new system is to modulate a carrier of 45 kilocycles with the sound signal picked up by a microphone in the television studio. Thus, a complex wave is produced, from which the sound could be obtained by receiver circuits tuned to 45 kilocycles. Actually, however, the sound signals are not radiated at 45 kilocycles. The television signals consist of frequencies up to 40 kilocycles. In the sound and sight broadcast, the 40 kilocycle



A VIEW OF THE COMBINATION TRANSMITTER
Edwin K. Cohan and William B. Lodge operating the new transmitter and a converted Scott receiver used in some of the first tests

television signal and the modulated 45-kilocycle carrier are combined and both transmitted over a single band on a *fundamental carrier of 2800 kilocycles!*

The receiving set, Lodge pointed out, detects and reproduces the signal. Frequencies up to 40 kilocycles are applied to the terminals of a neon tube to reproduce the picture. The 45-kilocycle modulated carrier-wave contains the sound, and an additional receiver circuit tuned to that frequency can be utilized to obtain this audible portion of the program. This system is shown diagrammatically in Figures 1 and 2.

Prior to the launching of the new system, Lodge suggested the use of a single television receiver, with special modifications, to receive both sight and sound. In the television receiver, he said, it is only necessary to insert a simple filter at the terminals of the neon lamp to prevent the 45-kilocycle voice carrier from interfering with the picture. It is also necessary, he said, to add a second (Continued on page 314)

AN ORCHESTRA WITH A "GHOST" CONDUCTOR

Harold Stern's orchestra in the St. Moritz Hotel playing under the leadership of his image and spoken word in a television receiver. Mr. Stern conducted the orchestra from the television studio one mile away



SCHEMATIC OF THE SYSTEM

Figure 2. Sketch shows the layout of the various circuits for modulating both sound and sight on a common carrier wave

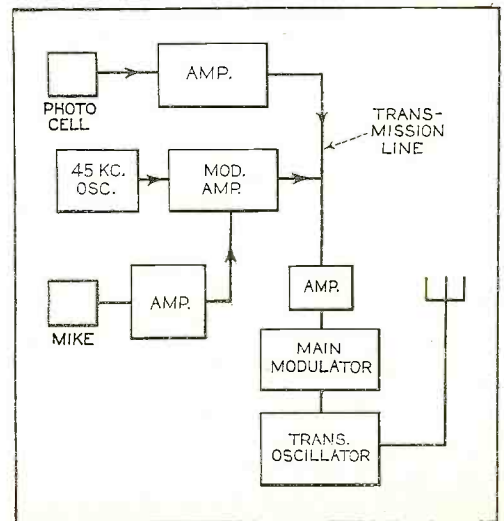

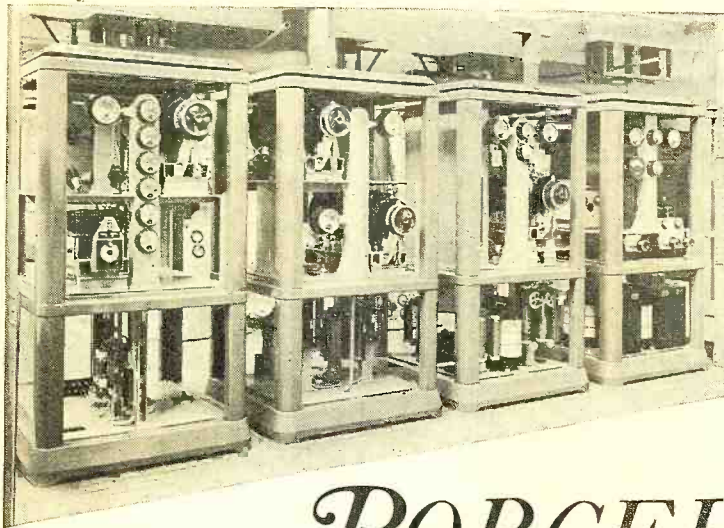

Figure 2. At left. Initial stages of the new Leipzig 150 kw. transmitter including oscillator, amplifier, harmonic generator, modulator and crystal control units

Six new broadcasting stations this year incorporate a number of which is porcelain equipment in the station. This use the usual steel construction, is by absorption and troubles caused

PORCELAIN BUILT

FOLLOWING a general trend in Europe, Germany is at present increasing the power of six of its most important radio broadcasting stations. These are: Berlin, Hamburg, Breslau, Munich, Leipzig and Frankfort-on-Main. The transmitting equipments for the latter three stations are especially interesting, as they involve several entirely new features. The largest of these will be Leipzig, a 150 kw. station, which will use four newly developed 140 kw. tubes in its output stage. The operating wavelength will be 389.6 meters, allowing a correction of $\pm 5\%$. The station will actually be located at Pegau, a small village in the environs of Leipzig. After a series of transmission tests and field strength measurements this place was found as particularly suitable. Furthermore, a 6000-volts high-tension line passes nearby, making power supply easy. The opening of the Leipzig 150-kw. broadcaster will probably take place this Fall.

Figure 1 shows the plan layout of the new Leipzig transmitting station. The equipment is built in porcelain units, which are entirely self-contained and which represent the different stages of the transmitter. The first unit on the left side contains the crystal oscillator and one stage of radio-frequency amplification. Next comes the unit for the harmonic generator, followed by another radio-frequency amplifier unit.

LAYOUT OF TRANSMITTING ROOM

Figure 1. Shows the arrangement of all the units to be used in the high-powered radio station at Leipzig, Germany

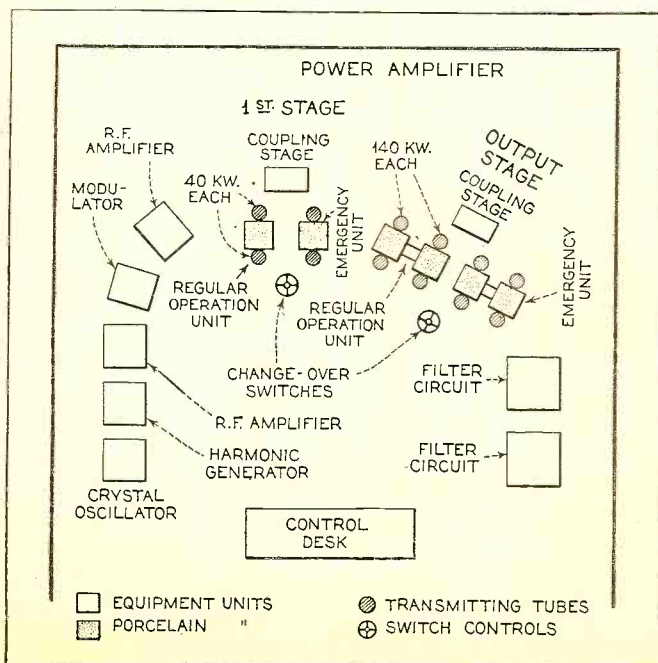

Unit No. 4 houses the modulating equipment, consisting of a high-quality speech amplifier. Modulation takes place in the fifth transmitter stage, i.e., radio-frequency amplifier housed in unit No. 5. A special system of grid-voltage modulation is used. All these units are designed for a wavelength range from 250 to 445 meters.

A close view of these initial stages of the transmitter is given in Figure 2. In the left center of the first unit the vernier dial controlling the crystal oscillator may clearly be distinguished. The thermostat housing the oscillating crystal, which is located behind the vernier dial, may better be seen in the center of the front unit in Figure 3. Here several of these units are shown on the test stand of the manufacturers, C. Lorenz AG., radio manufacturers of Berlin-Tempelhof, a company controlled by the International Telephone and Telegraph Corporation of New York. Other transmitter stages are shown in Figure 4 in the workshops during construction. The second unit from the left in Figure 2 is the harmonic generator, the third unit being a radio-frequency amplifying stage. In the fourth unit is housed the modulating speech amplifier.

These five initial transmitter stages of the Leipzig equipment are followed by the power amplifier as also may be seen in Figure 1. This power amplifier consists of an input stage of two high-power transmitting tubes of 40 kw. each and of an output stage using four specially-developed 140-kw. transmitting tubes. This gives a total anode dissipation of 560 kw. in the last stage. All high-power tubes are water-cooled, the water-cooling system being located directly underneath.

By Paul J.

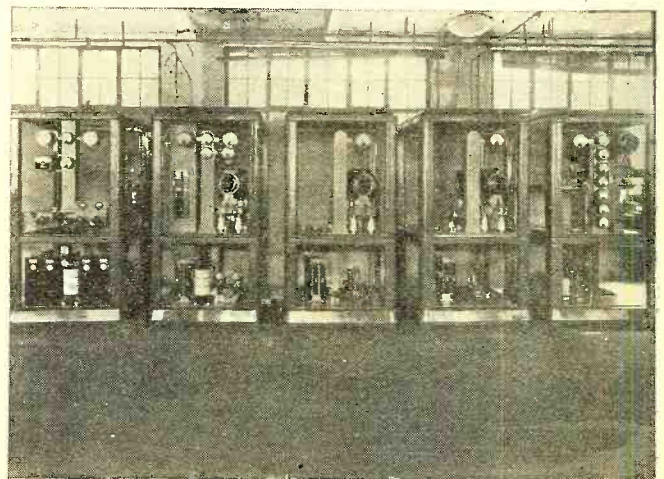

UNITS UNDER CONSTRUCTION

Figure 4. View of the transmitting equipment for Leipzig, Frankfort and Munich under construction at the factory

Figure 5. At right. Porcelain mounting pillars for the high-powered water-cooled transmitting tubes that are to be employed in the new European transmitting stations

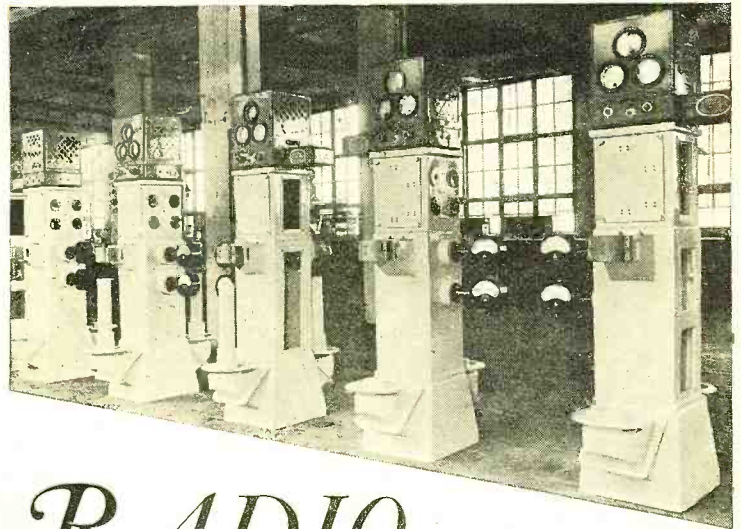

to be in operation in Germany for ber of novel features of design, the lain throughout for mounting the of a ceramic material, rather than aimed to eliminate the usual losses by feed-back in the transmitter

GERMAN RADIO

The units of both power-amplifier stages are almost entirely porcelain built. Thus excellent insulation and at the same time rigid construction is insured. One hollow porcelain pillar is used for holding two water-cooled, high-power transmitting tubes. Several of the tube stands may be seen in Figure 5, ready for installation. A metal case on top of the pillars houses two grid-current milliammeters; one for each of the two power tubes, as well as one common grid-potential voltmeter. The two ammeters for measuring the anode currents of each tube are seen extending on one side of the porcelain pillars. An input stage unit of the Leipzig power amplifier consists of one such porcelain tube-stand for mounting two 40-kw. tubes.

Gordon Fischel

To hold the four 140-kw. tubes in the last stage, two such stands are used, forming one output-power unit. Such an output stage is shown in Figure 6. The tubes (pipes) connecting the water jackets of the transmitting tubes to the water-cooling system may clearly be seen. Between the two porcelain pillars metal piping may be seen, containing the various high-tension and low-tension leads of the power tubes. All leads are thus effectively screened.

The porcelain units of both power-amplifier stages will be provided in duplicate, that is to say there will be a second porcelain stand for two 40-kw. tubes in the input-power stage as well as a second unit of two porcelain stands for four 140-kw. tubes in the output-power stage. This is clearly indicated in the layout of Figure 1. These duplicate power units will allow immediate replacement of the extra unit in operation in case of tube breakdown. For changing over from one

power unit to the other during operation of the transmitter, the special change-over-switch shown in Figure 7 is employed, one switch being provided for each of the two power-amplifier stages. Controlling of these switches may be conveniently and almost instantaneously accomplished by means of hand wheels located in the transmitter room at the appropriate power units indicated in Figure 1. Long interruptions of program caused by the necessity of replacing power tubes will thus be practically eliminated.

The water-cooling system for carrying away the waste heat from the water-cooled, high-power transmitting tubes, capable of dissipating several hundred kilowatts, will be located underneath the transmitter room. No hose coils will be used by this system for connecting the water circulating and cooling device to the water jackets of (Continued on page 294)

150-KILOWATT OUTPUT STAGE

Figure 6. Here are seen two porcelain pillars with 140 kw. transmitting tubes in place. Casings above contain various instruments for measuring operating potentials

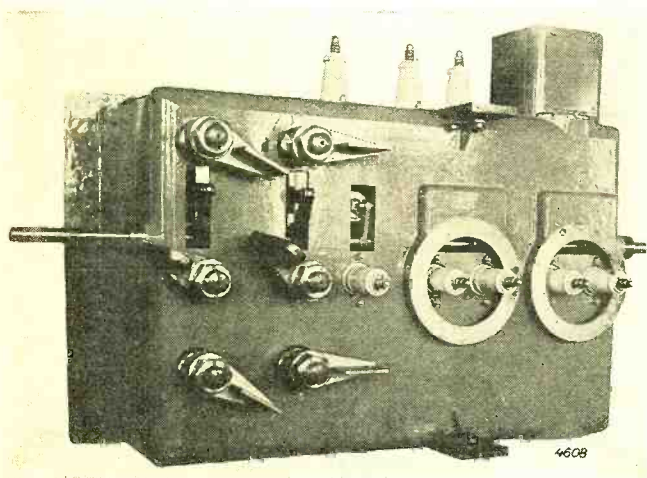
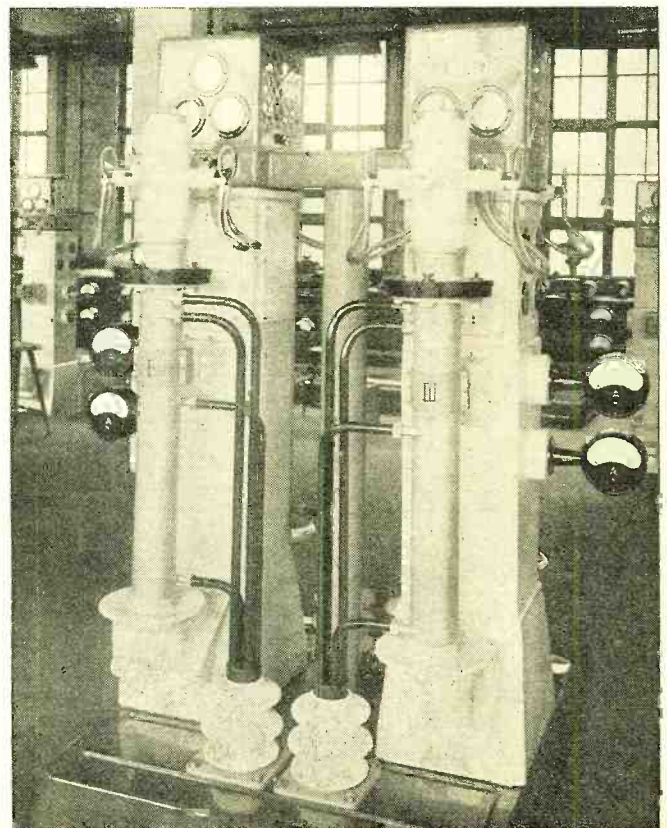

CHANGE-OVER SWITCH

Figure 7. This is one of the new type porcelain mounted change-over switches to switch tubes in case of blow out

Rejectostat Reception

Describing a complete receiver system, including a balance feeder antenna for eliminating pick-up of electrical interference from the input circuits

By Lewis M. Clement*

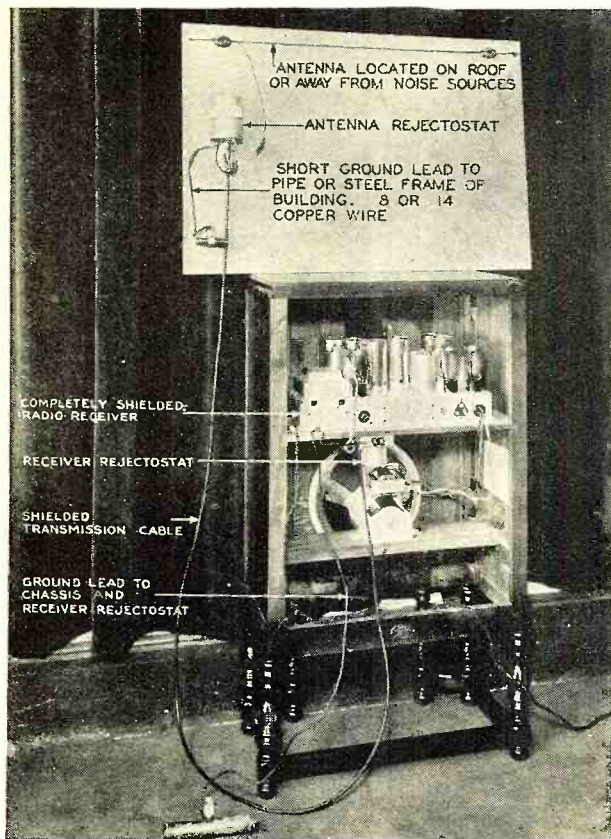

THE COMPLETE SYSTEM

Figure 2. Illustrative representation of the new antenna system from aerial to ground, including the completely shielded receiver

FOR the last few years receiver manufacturers have been devoting a great deal of their time to the development of receivers, using more tubes or special tubes, receivers with improved sensitivity, selectivity and fidelity, but have overlooked the real problem, which is the elimination of noise (man-made static). The general use of receivers with better fidelity and greater sensitivity has been hampered to a large extent by almost ever-present noise, the greater part of which is man-made.

A number of agencies have done admirable work in tracing this noise down and eliminating it at its source. Complete elimination of noise in this way is inherently expensive, as new sources of noise appear as soon as old sources are eliminated. This work should continue in all cases where it is economically feasible.

The elimination of atmospheric static caused by natural electrical disturbances, lightning,

* Kolster Radio Corp.

TRANSMISSION MEASUREMENTS

Figure 8. These curves show the transmission ratio of the new antenna, which equals the input in microvolts divided into the output in microvolts

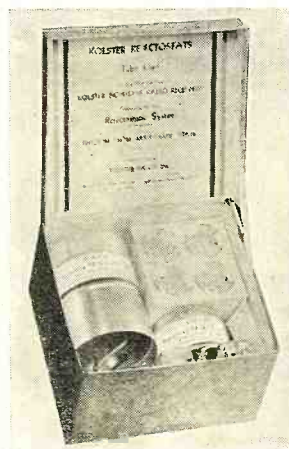
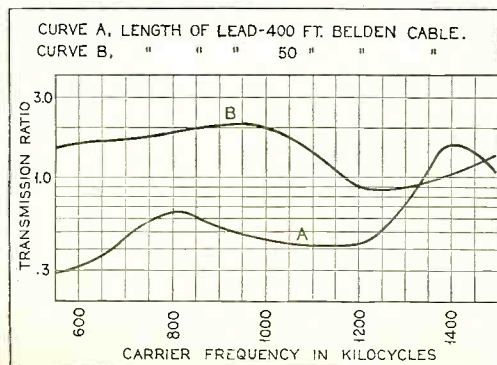

PARTS KIT

Figure 7. The complete Rejectostat kit of parts comes packed in a carton as shown

etc., is, however, as far away today as it has been for years, and the rejectostat system does nothing to eliminate this type of interference.

Each time an electric light is switched on or off, each time a small motor starts or stops, each time a spark of any kind takes place, electric waves are set up, and if they reach a radio receiver direct or by way of the antenna or back through the power supply line they make themselves apparent by producing clicks, crashes, bangs or buzzes in the loudspeaker. These noises are either intermittent or constant. A motor with a sparking commutator will produce a constant grinding noise; a violet-ray machine makes a terrific, mushy crackling of extreme intensity. These disturbances make radio disagreeable to listen to and in some cases drown out the programs altogether. Street-car lines, electric trains, power lines, elevator-motor circuit breakers, dial telephones, vacuum cleaners, and many other devices which in themselves are indispensable and invaluable aids to modern comfort, all help to create the vast background of disturbing noise known throughout radio circles as "man-made" static.

Pathways for Interference

The interference from these sources may reach the receiver (conductively) through the power circuits and power transformer or through an exposed or long and improper ground lead. If the interference is radiated by the noise-making device or exposed wiring connected to it, it may be picked up by exposed or improperly shielded coils, condensers, leads, etc., in the radio receiver itself, or it may reach the receiver through the antenna or the antenna lead-in.

By a careful and logical study by engineers of the Kolster laboratories, this "back-door pick-up" has been eliminated. This involved proper location of parts, shielding of all coils, condensers and grid leads, proper routing of leads,

SENSITIVITY MEASUREMENTS

Figure 9. Curves showing normal receiver sensitivity as compared to sensitivity with a 50-foot and a 400-foot transmission line

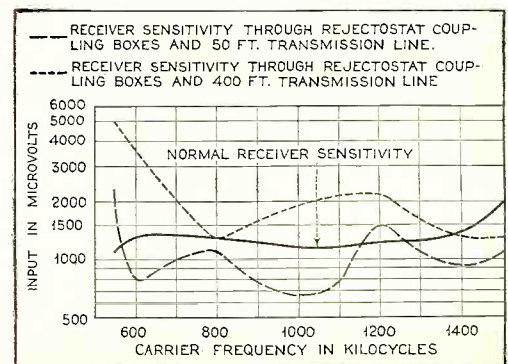

grounding of circuits and attention to important small details sometimes overlooked by the radio engineer. The power transformer is shielded externally and has an electrostatic shield between the primary and other windings.

The antenna and ground leads are twisted, shielded and led from the top of the shield housing to the antenna coil. This minimizes the amount of antenna-circuit wiring inside the receiver chassis.

The Kolster receiver is so completely shielded that when the antenna and ground leads are connected together, the exposed ends shielded and tube caps inserted in the ends of the tube shields, only the strongest local stations can be heard when the volume control is turned up to maximum. It is obvious, then, that if the antenna could be placed where it does not pick up noise and the lead-in could be completely shielded, the receiver could be placed in a noisy location *without picking up noise!*

A shielded lead-in of the ordinary type, because of its high capacity in shunt with the antenna, highly attenuates the signal voltage. In most cases the signal is apparently attenuated faster than the noise, which makes the ordinary shielded lead-in of little advantage.

Measurements made on No. 18 twisted pair, enclosed in a copper-mesh shield, indicates that it has a surge impedance

$$\left(\sqrt{\frac{L}{C}}\right) \text{ of approximately 60 ohms over the broadcast range.}$$

By the use of such a shielded-pair lead-in, with proper matching transformers at the antenna and receiver terminals of the line, the antenna can be located in the most desirable place and the receiver can be installed in any location without regard to noise or accessibility to the antenna.

It is obvious that if the antenna is so located that noise is

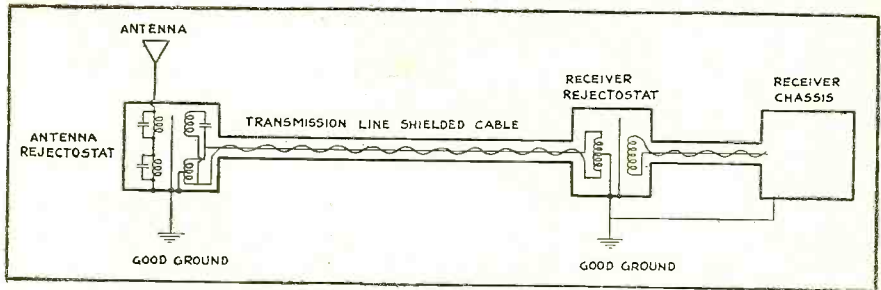

THE SCHEMATIC DIAGRAM OF THE FEEDER

Figure 5. General scheme for connecting the Rejectostatic system to a receiver

picked up by the antenna, quiet reception will *not* be obtained. For best results the antenna can and should be located 15 to 30 feet above the top of stores or apartment-house roofs or surrounding objects and as far away from power lines or other electrical noise sources as possible. A good ground must be provided.

Figure 2 is a pictorial representation of the complete system and shows its various elements: the properly located antenna, the antenna rejectostat, the short ground lead, the shielded transmission line, the receiver rejectostat, the shielded radio receiver and the ground lead.

Figure 5 is the schematic diagram of the rejectostatic system and shows the details of the antenna and receiver impedance-matching transformers. In both of these transformers the primary windings are shielded from the secondary windings, electrostatically.

Figures 1, 3 and 4 show typical installations in homes, apartments and business buildings. In each case the antenna is located in the best possible position for signal "pick-up."

Figure 6 shows the construction of the antenna and receiver rejectostates as well as the completed (Continued on page 315)

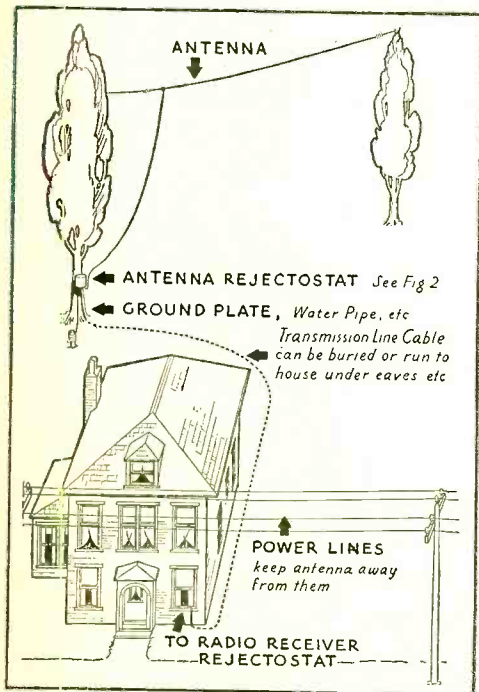

HOW THE SYSTEM IS INSTALLED

Figure 6. The photograph below shows the various parts employed

Figure 1, at left, shows the arrangement installed on a residence in which power lines run along the front of the house

Figure 3, at right, shows the arrangement installed on an apartment house building in two locations to eliminate local interference

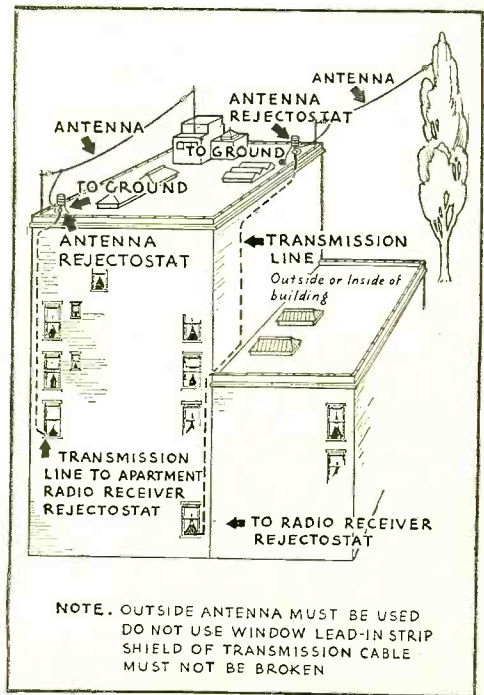

CONSTRUCTIONAL DATA ON A 10 TO 700

EVERYTHING

Television

Short

*This is one of the first tuned r.f. receivers to
The product of an experimenter, it provides
provision for 'phone, c.w.*

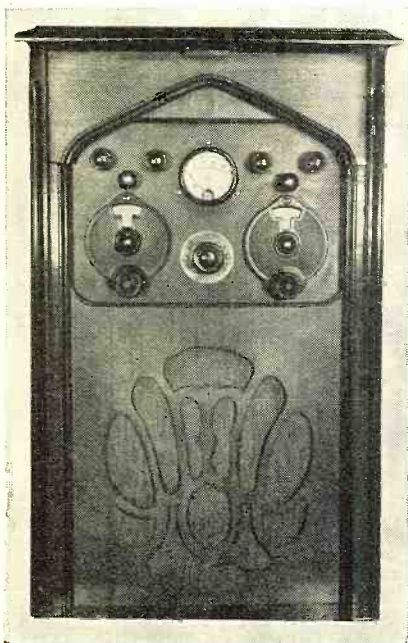

FRONT VIEW
*The control panel
of the combination
receiver covering
long and short
waves and televi-
sion*

By John M. Borst

IN the old days of radio there was only one kind of radio receiver; it covered all wavelengths then in use. At present receivers are made to cover a comparatively narrow band of frequencies and suitable to telegraphy, 'phone or vision separately. Old-timers in the radio game often regret this specialization; they feel that if a radio receiver cannot pick up everything on the air, it does not fulfill its purpose.

The covering of the short waves and the American broadcast band in a single receiver has lately become standard practice when the superheterodyne principle is employed. Switches have now been developed which are sufficiently reliable to insure the positive contact required for the high frequencies.

It was left to Samuel Whisk to bring the work to a conclusion and to produce a really universal receiver which is capable of picking up everything on the air, including television (sound and sight simultaneously), short waves, medium waves and long waves, if desired.

The circuit is of the tuned r.f. type, which means that the coils must be changed in all the r.f. stages and in the detector

circuit when shifting from one band to another. This is done with a multiple switch, by means of which the listener-in can exchange his coils in all the stages of the receiver, the same condensers being used for all bands.

The switch design employed can be made with any number of poles, according to the requirements. Therefore the principle can be applied to different conditions, and the example of the receiver described in this article does not mean that the circuit is limited to six wave bands or to a three-stage receiver.

The photographs illustrate how this system was worked out in one particular receiver model. The combination contains two complete units, one for television and one for sound and c.w. Let us consider the sound receiver first.

It has a wave-changing switch for six bands. By turning one knob, all changes inside the receiver are made simultaneously.

The receiver consists of one stage of r.f. amplification and a regenerative detector on the short waves. The 49 to 90-meter band is an exception, as it employs two radio-frequency stages. For reception on the broadcast waves there are two tuned r.f. stages and the detector is not regenerative. In addition, there is a band-pass filter. All tuning is done with the same dial which controls a four-gang condenser. The output of the detector is fed to a resistance-coupled amplifier stage and then to a push-pull output stage of -45 type tubes.

The television receiver is entirely separated from this one, with a separate power supply and resistance-coupled amplifier, terminating in two type -45 tubes in parallel which feed a Jenkins televisor. This receiver covers only one

THE RECEIVER IN THE
*Mr. Whisk is shown operating his
design he has not overlooked the*



CIRCUIT DIAGRAM OF THE ALL-WAVE RECEIVER

Figure 1. The connections for the multiple switch are shown in detail; together with the other circuits of the all-wave receiver

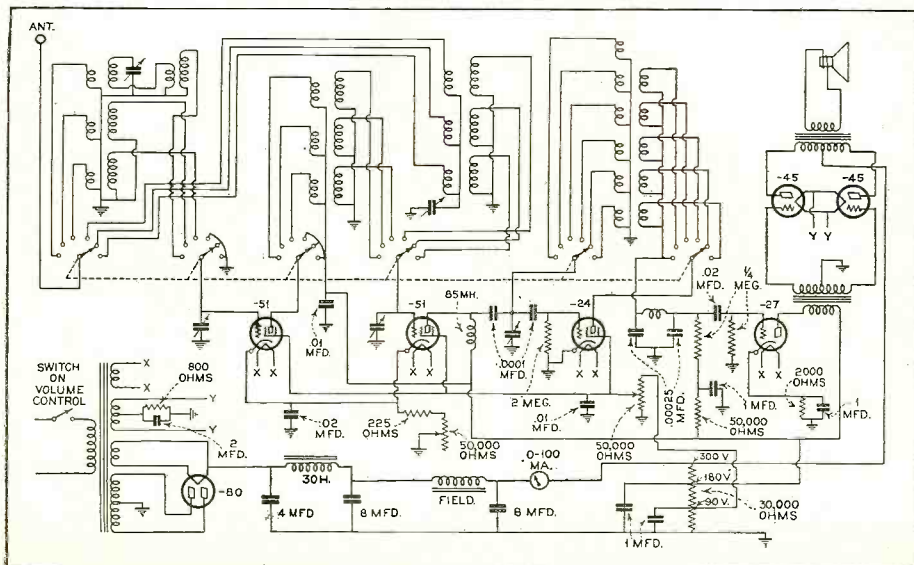

METER RECEIVER DESIGN THAT BRINGS IN ON THE AIR

Waves * * * *Long Waves*

cover all wave-bands without plug-in coils. some unusually interesting features, including and television reception

wave band, from 90 to 200 meters. Sound can be received with it by throwing the switch on the televisior.

The combination contains only two tuning dials, one for television and one for 'phone or c.w. The wave-change switch is seen in the lower center of the front panel.

The four knobs on the top of the panel are, from left to right: the volume control of the television receiver, the volume control of the sound receiver, the regeneration control and, the last one, a small antenna-coupling condenser which is in the circuit only on certain short-wave bands.

The meter is an 0-100 milliammeter in series with the plus B lead. The total plate current of the receiver goes through it.

For better understanding of the circuit, one should remember that it is a standard two-stage, radio-frequency amplifier and detector. The multiple switch takes care of the exchanging of the coils for the different wave bands, as shown in Figure 1.

In all cases the coils have one common connection. The aerial goes to the contact arm of the first section of the switch. The other terminals of the coupling coils are connected to the various contact studs.

Each of the primaries is in inductive relation only with its own secondary. The same is true of the secondary and plate coils. Every one of them is coupled to its companion coil for the same frequency band, but there is no coupling between coils which cover different frequency bands.

DESIGNER'S HOME
receiver. It is evident that in its advantage of pleasing appearance

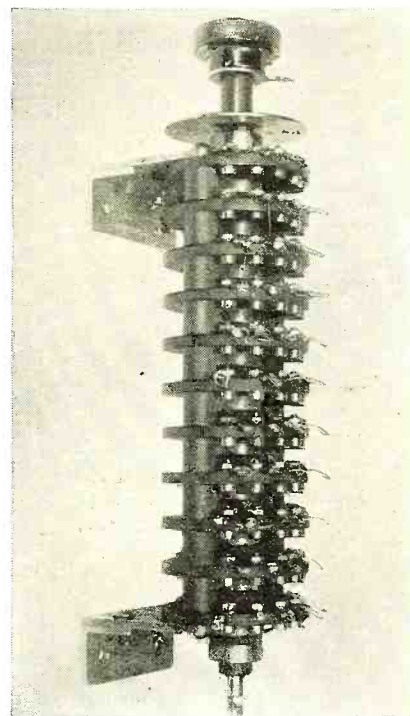

THE BAND SWITCH

This switch, which is the heart of the receiver, gives perfect control on all wave bands. The description in the text gives details of its construction

has its variable arm connected to the grid of the first tube. Its contact studs are connected to the secondaries of the antenna couplers for only three of the six wave bands. The other three (short-wave bands) do not use this tube. To prevent a floating grid and consequent high plate current, the remaining three studs are connected together and grounded. This grounds the grid and keeps it at its normal bias.

The third section of the switch selects the primary or the plate connections of the interstage transformers. The plate, therefore, is connected to the contact arm. To studs one, two and three the primaries of the interstage radio-frequency transformers are connected; these are for the 700-200, the 140-300 and the 40-90 meter wave bands, respectively. The remaining three studs are connected together and to B plus. There is, therefore, no coil in this circuit when the tube is not being used.

The tuned secondaries of this interstage transformer are connected to the contact studs of the fourth switch section, which has its arm connected to the grid of the second tube. Contact studs numbers 4, 5 and 6 (Continued on page 310)

CIRCUIT DIAGRAM OF THE TELEVISION RECEIVER

Figure 2. Its tuner unit is built into the same shield as the all-wave receiver tuner, but employs a separate amplifier and power supply

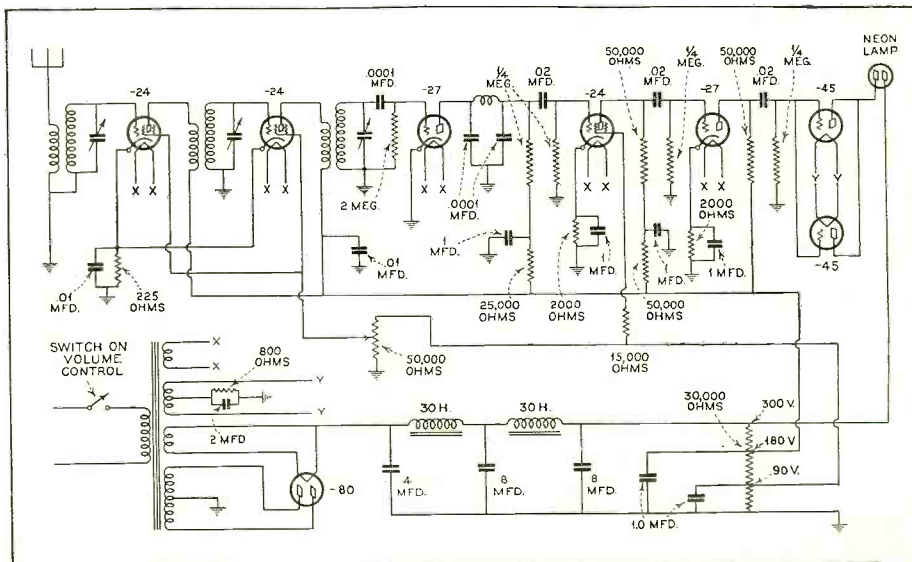



WHAT IS A MORON?

Webster says: "MORON—psychol. A person belonging to that group of the feeble-minded whose mental level is that of the normal child of from eight to twelve years of age inclusive (Henry H. Goddard)."

MY affirmative to the letters received by the editors of RADIO NEWS is based upon the biological and psychological effects of the transmission of high-frequency radio waves that are already known to the physicist, the biochemist, the physician and the psychologist. The fact that these waves, as well as other waves of the electro-magnetic spectrum, produce evil effects on living tissues is one that our modern age should consider seriously before going very much farther with its scientific development.

As my discussion is to appear in RADIO NEWS, it would probably be better to refer to a few articles on this subject that have already appeared within its pages. Looking back over the past issues, I find in the March, 1932, issue an article on "Radio Surgery" and in the April issue an article on "Radio Fever," both of these showing definitely the damaging physical effects of radio waves on living tissues. But it seems that even the scientists themselves have not taken warning, but have gone on building radio and other high-frequency machines and apparatus built on plans and principles diametrically opposed to the, at present, mild warnings of our instincts. Our instincts, for instance, warn us of heat and electricity and some other intense vibrations as dangerous energies. But we have believed that we are able to harness fire and electricity in these machines and I, personally, have begun to wonder whether or not we are going to "burn" ourselves with them.

The Damaging Effects of Radio Waves

Thus far, the damaging effects of radio waves on living tissues have been produced directly in the bodies of the experimenters' test animals, such as guinea-pigs, frogs, chickens, etc. But who is able to say exactly when these dangerous radiations are going to affect human beings themselves or when they may be used for the destruction of human beings? The coagulation of the brain cells of a chicken by radio waves has already been accomplished in the laboratory so that the bird became an example of living death—brainless—almost motionless. This was an experiment already reported in RADIO NEWS. I see eminent danger in the pursuit of these experiments with regard to the damaging effects they might produce on both the scientist and unsuspecting layman if unknowingly subjected to a great enough influence of these high-intensity, high-frequency fields.

We are continually increasing (Continued on page 280)

IS RADIO A RACE OF "YES" says Vladimir Michinov

Read These Letters

Below are printed six letters that have come to able number received during the last two years, from the accepted scientific viewpoint, but in spite of the editor's opinion, the mistakes made in most scientific knowledge and the layman's wont to were, quite evidently, from people suffering various has advised these people to consult a psychiatrist, to other readers who have not corresponded with viewpoints. The statements of Mr. Michinov and letters to these authorities. They are published

"In a recent article in RADIO NEWS it was pointed out that radio waves could produce fever in humans and even effects like paralysis or coagulation of the brain cells.

"I have a small transmitter station for short waves and have been successful during the last few months in communicating with many amateur stations hundreds to thousands of miles away. But if I work for a long period of time with this transmitter, I find that I get terrible headaches, especially in the evening. Do you think I am in danger? Can the radio waves from a small set hurt my nervous system or brain cells? I am really worried."

(Signed)

"RADIO NEWS has pointed out that electric waves of the ultra-short-wave variety are able to influence living animals.

"In one article I read in the magazine, it showed the brain of a chicken paralyzed by short radio waves and also the picture of a frog whose leg was paralyzed by short-waves.

"Now, as we all know radio waves are only a small part of the electro-magnetic spectrum, how about other wave lengths? What influence have they on the human body?"

"I have done extensive reading along these lines and may I point out the fact that we are submitted day-in and day-out to the cosmic rays which penetrate everything—even several feet of lead. These rays certainly penetrate our body. No wall of the strongest constructed building can protect you. What do you think? Is there any terrible action to be expected from such powerful radiations as these? What do these waves actually do? How can we protect ourselves from this danger? Do I correctly see the world radiated by nature as well as scientifically by radio till everything living is killed in the future and the only thing left some lower animals, birds and other forms of living matter?"

(Signed)

"I read in RADIO NEWS an interesting article in the November issue which states that it is possible to locate the position of a ship or wireless station with a so-called direction finding loop. This, it was stated, is of the greatest importance in navigation for both airways and waterways.

"But isn't this scientific apparatus causing man to degenerate—to lose his natural instincts? Isn't civilization lessening our instincts and making man so dependable on scientific apparatus that his brain is deteriorating. Look at the old Egyptian runners who had only their instincts to direct them and look at our own desert scouts of the last century who, without compass or any instrument, made their way over trackless wastes of desert for days and days until they finally found a tiny oasis, a little spot of water which makes possible the crossing of these deserts. For thousands of years men such as these have led large caravans, the only communication possible between distant countries.

"Consider also the animals and the birds. Birds migrate North and South and find their old nesting places yearly. Carrier pigeons return to their homes thousands of miles away without directional apparatus, except their instincts. Animals, cattle, dogs, etc., are able to find their homes though carried hundreds of miles away. I could continue with many more examples.

"What is your opinion of all this unnatural scientific development on the human brain? Will it make us a race of morons?"

(Signed)

"Your article on television in the issue of RADIO NEWS I read over and over again. It contained a large amount of technical description that was over my head and although undoubtedly it may work, I am wondering if these complications are really necessary.

"What about the gazing crystal. Everyone knows that if you

MAKING US MORONS?

Dr. Irving J. Saxl says "NO"



NATIVE INTELLIGENCE

A glance at this picture of Dr. E. F. W. Alexander, electrical genius of the General Electric Company, is sufficient to illustrate the highest type of intelligence existing in the modern race of mankind

to the Editor!

the editor recently that are typical of a consider- The editor has answered each one as received of this many of the letter writers were skeptical. of the letters were caused by lack of sufficient generalize. A number of the letters received degrees and types of mental disorders. The editor The thought occurred that it might be interesting the editor to have this subject treated from both Dr. Saxl are, therefore, the result of sending the as free statements on a controversial subject.

want to see distant things happening, you get a gazing crystal to look into. I see no crystal in the set described.

"I have been to many a seance and have seen wonderful things in the crystal, the medium having shown me, time-after-time, the real stuff in distant vision. Won't television have a bad effect on the real crystal-gazing ability of man in the future?"

(Signed)

"Your authors in RADIO NEWS write many articles on radio receiving apparatus, but I think it is all "the bunk."

"You don't need a crazy radio receiver in order to hear music and voices in the air if you really open your inner mind and ears. All this scientific hollaballoo comes because you fellows have no religion any more. You believe, I suppose, that science and radio are going to give you back what the Lord has taken from you, but I can tell you this: radio is an instrument of Satan and all the science and doctors cannot give you back the ability to hear what's going on in the air if the Lord has made you all deaf against it. I know that most people will never be able to really hear any more.

But I! I hear without any apparatus whatsoever. If I lie on my back in the evening, have the windows open and close my eyes, believe me, I hear real beautiful music, sometimes gay and sometimes serious. It is wonderful music and not of this earth at all. And it is not silent by any means—it is sometimes so loud it seems that other people will hear it coming out the open window, but when I look out, nobody is paying any attention. No, sir, I have no radio in my house—I would not let one of those devilish instruments ruin the morals of my family.

"Sometimes I hear a voice that speaks to me and warns me and quiets me; sometimes there are several voices in a chorus. I hear radio without any apparatus whatsoever and I believe that if people will think more of their religion and open their minds to the truth they would not have to spend good money for these instruments of Satan."

(Signed)

"I have read much about locating ores and minerals by radio prospecting with special apparatus. What would you answer if I asked you to explain this phenomena in connection with the activity of the dowzers?"

"Your radio apparatus, which is so complicated no one can understand it, is supposed to track hidden oil, ores and minerals. I do not know how one does it, but I know one thing—it is terribly complicated and it is thoroughly impractical.

"I would like to ask you three questions. Who actually finds good new oil fields? Who blazes the trail? Is it a radio engineer? I don't think so. The opening of vast areas of riches in the field of the mining interest has always depended on the work of practical men. They use no radio or measuring instrument. What they used was their unfailing mind powers which drove them to the place where the hidden treasures lay.

"We should go back to the old-fashioned divining rod. It is so easy to carry a rod. You go over the place where your mind tells you to expect to find the minerals you are looking for and as you pass over the spot, your od moves downwards and strokes the earth. You can always rely on the rod. Its story goes back as far as Moses who went out to find a spring and when his rod thumped three times upon a rock, there he found water. God guided him through his mind and the rod moved. What has been used for thousands of years and still proves valuable and is simple to handle certainly has something to it.

"Don't you think that with all this scientific development man's brain and instincts are spoiling in disuse and that except all rely on God and his guidance, man is really leading himself to the abyss with all his scientific tommyrot."

(Signed)

IT is with hesitation that I accept the invitation to give the scientist's viewpoint to the questions raised by some readers of this paper. Is this wonder tool of the modern sciences, radio and its allied arts, that has given us the world's best means of communication and entertainment, that has made possible the newest researches in the fields of physics, medicine, chemistry, biology—is it really making us a race of morons? And if not, what, then, is at the bottom of these fears that repeat themselves time and again?

It is here where I hesitate, fully realizing the fact that it is necessary not only to answer these questions from the viewpoint of the pure physicist in words and language understandable to the layman, but in addition to set down some general principles of systematic and logical thinking that have to be understood first.

Of course, some of the letters sent to me cannot be taken too seriously. Take, for instance, Letter 5. If I assume that all of these communications came from normal and healthy persons, I would be willing to believe that the writer of this letter actually had heard music playing without using any apparatus. I believe that he wrote the letter in good faith, but if he is normal it is not really necessary to introduce magic, heaven and hell for experiencing the phenomena he describes.

Let us read the letter carefully. It has been found that he is living in an apartment house several stories high. There may be several radios in the apartments of other people. He himself points out in his letter, "If I lie on my back in the evening, have the windows open, close my eyes"—Does it take so much imagination to trace the acoustic impression back to its source? Is it really necessary to raise all that mystery for telling in simple language that "he hears the neighbor's radio?" However, in my opinion, other parts of his letter make me think he is afflicted with a certain nervous disorder and should consult a psychiatrist.

Quantitative Considerations Necessary

Of greater seriousness, of course, is to deal with those letters that are based upon the biological phenomenon of high-frequency oscillations, and it is here where we might find a hand-hold for analyzing the main mistakes of many of these letters.

This main source of error is based upon the fact that while it is true that all actions in nature (Continued on page 280)

“YES”

(Continued from page 278)

our broadcasting power. All the leading transmitting stations tend in this direction. And again, especially, the trend of modern radio development in the region of the short waves and the ultra-short waves is an added danger. The ultra-short waves are known to have a much more intensive biological action than even the normal wavelengths of the broadcasting bands. The danger of hurting operators standing near the ultra-short-wave machines and men in the neighborhood of the transmitting towers increases continuously. Another influence that has been recently discovered is the effect on the growth of plants near these powerful transmitting stations. How do we know that these rays are not slowly affecting human growth and the development of the human brain?

When we consider that television itself is now stated to be better on the short wavelengths, what will be the result of the introduction of this new science on the ultra-short-wave bands, with the necessary increase of powerful transmitters especially for this use? Here again we may be unknowingly increasing our risks from apparatus and instruments of this type.

We know, furthermore, that the cosmic rays are very much shorter than the shortest rays radiating from materials like radium and, in fact, shorter than any other known electromagnetic radiation. It has been stated that these waves may have some connection with the development of biological evolution on earth, although this is not sure. We do know, for instance, that freaks and mutations can be produced by radiating egg cells of many creatures with cathode rays, with radium and with X-rays and ultra-violet rays. These, in some way, seem to influence the chromosomes and genes which have to do with heredity. But do we know just what the effects of radio waves on living creatures are, even if they may be small?

Effect on Human Life

Take the sun's rays, for instance, that contain considerable ultra-violet radiation and that produce the well-known sunburn on our skins. These are invisible rays only slightly shorter than the visible light rays. The radio waves we are speaking about are situated not far away in the spectrum on the longer side of the visible spectrum.

I think, therefore, there may be a definite danger for the human race in the further development of radio and kindred sciences if these effects are not studied carefully before hundreds of thousands or millions more kilowatts of radio power are turned loose on our world.

Considering the question from another viewpoint, I also think that radio in its present form of non-education may produce a degenerating influence on the lives of future world inhabitants. In reducing the price of radio sets during the recent depression, a much lower class of public has been able to buy receivers, and these have written in to the broadcasting stations demanding a lower type of program—(Continued on page 315)

(Continued from page 279)

“NO”

produce reactions of some sort, it is equally true that the final effect of them is *entirely based upon their quantity*. Qualitatively, then, these harmful reactions exist. But, quantitatively, they are usually so small that they lie below the threshold of sensibility, or they may compensate each other. Which means that they are neither noticed by our sensation organs nor by clinical changes in our organisms.

Take, for instance, the question of danger in Letter 1. This man has a small transmitting station for short waves and communicates with amateurs thousands of miles away. This tells us already that he is working at a wavelength between 20 and 40 meters, otherwise he could not reach persons thousands of miles away, as longer wavelengths would not carry the distance and ultra-short waves are not reflected by the Heaviside layer. Small transmitters of this type have been used by thousands of amateurs, and no biological influence whatsoever has been found to exist nearby. The waves are too feeble. The headache of this amateur simply comes from staying up too late in the evening and straining to hear weak signals. He should go to bed earlier.

While qualitatively these rays *do* have a temperature-raising effect, quantitatively speaking it does not make any difference when our body temperature is raised, for instance, one thousandth of a degree. The quantity of this

radiation is not strong enough to hurt us. Of course, should this high-frequency energy be concentrated upon a field of small diameter, the relation of total available energy to the biological tissue exposed would be greatly different and it might then be possible to paralyze the brain of a small animal between small electrodes. This is not the case with amateur transmitting stations. With radiating parts many feet in length, the total available energy, distributed over so wide an area, is too small to be able to influence human tissues in their neighborhood.

Benefits Versus Danger

Mr. Michinov mentions the danger of the medical application of high-frequency fields for doctor and layman. I agree with him insofar as there *is* a danger. But shall we be afraid to approach a new field because it is dangerous? Let us look at the two charts below, following computations of Dr. E. Schliephake, showing the time necessary to kill staphylococci and tubercle bacilli in dependency on temperature. We see that a tubercle bacillus dies in about one-fourth of the time in the high-frequency field that it would take to die at the same temperature, normally heated. A specific effect also can be noted for the staphylococci. Here we have the beginning of an art for *giving unfavorable living conditions for the enemies in our bodies*, without hurting the human body. Shall we stop working with this tool because it is dangerous? We might as well stop working with immunization by vaccination or serum therapy or X-ray therapy because they are dangerous, too!

As (Continued on page 315)



RADIO PARALYSIS

The frog's leg, above, and the chicken's brain, below, have been totally paralyzed by the influence of ultra-short waves, as described in a recent article in RADIO NEWS

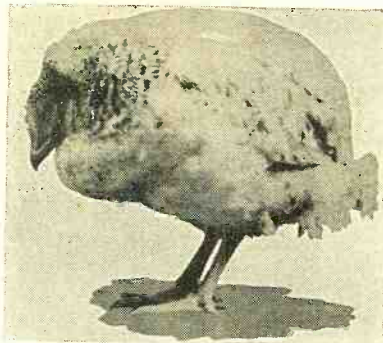

RADIO WAVES KILL GERMS QUICKLY

The chart, at left, shows how staphylococci are killed much more quickly in a high frequency condenser field, by temperature other than in a water bath. The chart, at right, shows same effect for tuberculosis bacteria

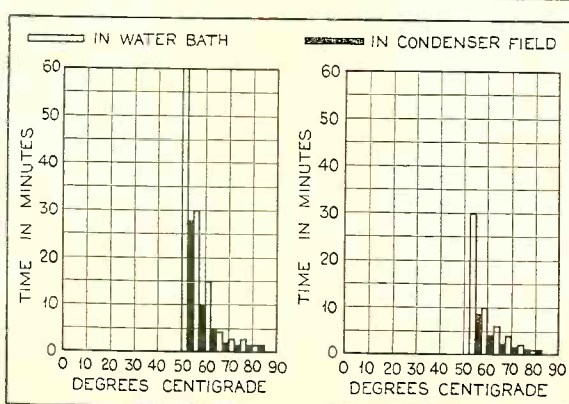

A Microphone for Your Buttonhole

No longer need a speaker be restricted to the area in front of a microphone stand. This new device goes with him

By Thomas Clifton



A SENATOR WITH AN "EAR" TO MILLIONS

Hiram W. Bingham, of Connecticut, wearing a new type of buttonhole microphone.

WHAT appears to have opened a new field for radio and sound reproduction has been introduced practically within the last month in the form of a new microphone (see Figure 1). As the name makes it apparent, it is worn in the lapel buttonhole, and as such it has to be very small, light and unobtrusive.

There are a number of advantages in using the new microphone. The speaker is not "microphone conscious" and does not need any special technique in using the microphone. He can move freely around the platform, gesticulating and addressing his audience in the usual way. The only difference is that he wears in his buttonhole, instead of a flower, this tiny microphone, from which a cord goes first to a volume regulator which is carried in the pocket, and from there 15 to 20 feet away to the amplifier. With this regulator the speaker can

control the volume output of the sound himself, so that a second operator for making switching procedures is unnecessary. While it is a desired advantage that the face of the speaker is not hidden by a row of microphones, it is felt especially agreeable that the speaker does not have to stand near the microphone in order to secure reliable sound pick-up.

Inconspicuous Sound Pick-up for Churches Made Possible

It is now possible with this device to introduce the advantages of sound amplification into places where the open use of technical instruments is undesirable, as in churches, temples, etc. By using this microphone, the preacher simply plugs in the connecting cord at a convenient point in the pulpit.

While a microphone is sensitive to the speaker's voice, it naturally has to be sensitive also to noises and sounds in its surroundings. This holds true for the general type of microphone, but the new buttonhole microphone works practically exclusively in its closest neighborhood, giving a reduction of background noise.

Figure 2 shows a cross-section through a modern buttonhole microphone. The pressure upon the carbon is transmitted through a thin strained membrane "M" which is made of a special metal alloy, thereby avoiding inertia and resonating frequencies, as is often the case with the ordinary carbon membrane.

Below this membrane, and protected from falling out of the open space by a felt washer "F," are the carbon grains and powders "G."

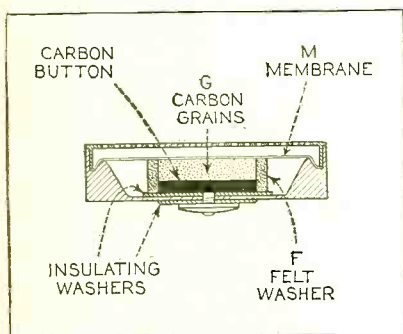

WHAT IT LOOKS LIKE

Above: (Figure 2) The inner construction of the new microphone and at right (Figure 1) a picture of the device, showing the fountain pen clip, the connection cord and the plug

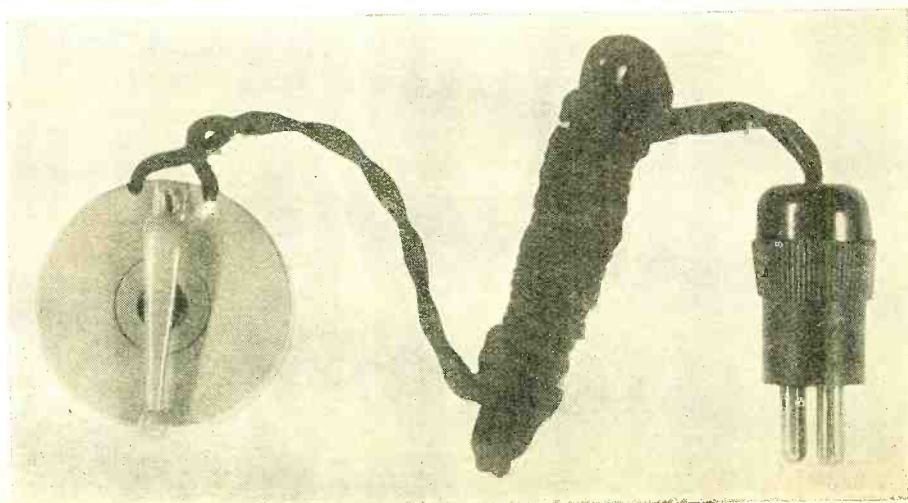

HIGH QUALITY AMPLIFIER DESIGN FOR A Heavy Duty P. A. System

The amplifier described is capable of operating up to fifty dynamic speakers and is particularly well suited to meet the coverage requirements for outdoor arenas, large hotel installations, etc. Its electrical output is substantially flat from 30 to 10,000 cycles

WHEN it is necessary to cover a large territory with a public-address system, it becomes impractical to employ only one speaker or one cluster of speakers. The sound would obviously be too loud for those people who are close to it, while it might be not enough for those far away.

A better distribution of sound can be obtained by placing a relatively large number of smaller speakers at strategic points. This requires a power amplifier of larger proportions than is usually available. Equipment for this purpose, as described here, has been designed to give a maximum output of 50 watts with but 2 percent harmonic distortion.

The final output stage of the power amplifier employs two 845 type tubes in push-pull. These are operated considerably below their rated capacity in order to obtain the very best of quality. For any type of outdoor work or for large halls, where there is a high noise level, this system is especially well suited.

The amplifier described here, and which may be constructed by anyone having a fair knowledge of radio building, is designed for use with the new dynamic microphone, but if for any reason a carbon microphone is preferred, the builder has only to replace the input transformer with another type which will be indicated below. In order to make the amplifier universal in use, facilities are also provided for the reproduction of phonograph records and the output of a radio receiver. The change from microphone to phonograph is accomplished by the throwing of a double-pole-double-throw switch. This cuts out the first stage and connects the pick-up to the voltage amplifier through the volume-control network.

Like most equipment of this type, the amplifier has been mounted on a rack. There are

By **Bernard J. Montyn**

Part One

three panels, each of which carries a separate unit. In order to prevent confusion, individual diagrams for each panel are shown here rather than a large diagram of the whole equipment. Interconnections between the three panels then complete the diagram.

Panel 1 supports the pre-amplifier stage and the voltage amplifier. The power supply for this section is mounted on panel 2. In this article we shall restrict ourselves to these two panels. On panel 3, the power stage is mounted with its own power supply included on this same panel.

A schematic diagram of the first panel is shown in Figure 1. This is mounted at the top and can be seen in the three photographs. The input transformer, T1, has a split, tapped primary which will match a dynamic microphone by paralleling the windings. The primary is also designed to match a 200 or a 500-ohm double-button microphone or a low-impedance pick-up. Similar split, tapped windings are found in transformers T2, T3 and T5.

Where so much amplification is provided, it is of course necessary to furnish a high degree of filtering, especially in the first stage. An additional filter section is therefore placed in the plate circuit of this stage and also in all the other stages.

The pre-amplifier brings the volume level of the microphone output up to about the same as that of a phonograph pick-up, so that the switching is done after this stage instead of before.

The signal next passes through the volume control. In smaller equipment one usually employs a potentiometer across either the primary or secondary of a transformer, but this obviously changes the impedance of the circuit and consequently the quality suffers. Some type of constant impedance volume control must be devised whereby

AMPLIFIER AND POWER UNIT

The front and rear detailed views of the power amplifier and power pack units corresponding with two top panels in illustration on following page

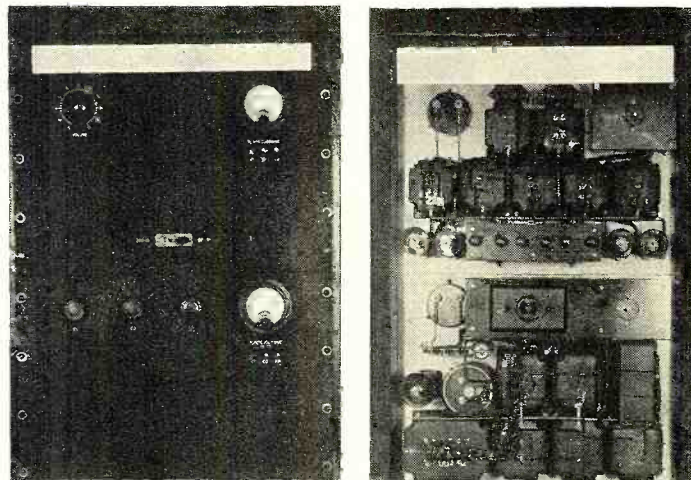

THE POWER SUPPLY

Figure 2. Below is the schematic diagram of the second panel. In order to stabilize the plate supply, a heavy bleeder current is drawn. Individual filter sections are placed in each positive lead

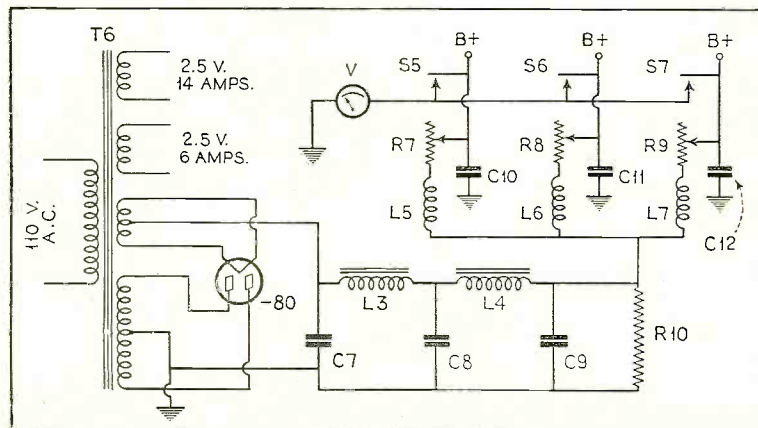

the matching is kept the same at all volume levels. This can only be done with a rather complicated network of resistors, all of which are varied at the same time and their variations follow a previously determined mathematical law. This system makes the impedance 500 ohms at all times looking into it from either side.

Now comes the voltage amplifier proper. It consists of one stage of shunt-fed, transformer-coupled amplification and one stage of push-pull. All stages employ the -56 type tube. The first stage, like the pre-amplifier stage, has a shunt-fed plate circuit. The primary of the push-pull input transformer, together with the $\frac{1}{4}$ -microfarad condenser, resonates at approximately 50 cycles. This causes a reinforcement of the speech frequencies around this figure and no doubt accounts for the singularly even frequency characteristic of the whole amplifier.

It might be well to call attention to the way the grid circuit has been filtered. Note the connection of the bias resistor and the grid filter resistor with the condenser across both of them. There is no condenser across the bias resistor, yet the signal does not pass through it.

In the push-pull stage a condenser across the bias and filter resistors is not necessary. The output transformer has a secondary for a 500-ohm line which leads to panel 3.

A curve of the frequency characteristic is substantially level from 30 cycles to 2000 cycles, then gradually rises to a slight peak at 8000 cycles and comes back to normal at 10,000 cycles. However, this peak is only three db. above the level at 1000 cycles. From the same curve it is seen that the gain in these two stages is 45 db. The gain in the first stage is approximately 20 db. and in the final power stage 40 db.; this makes 105 db. in all.

The output is sufficient to load up 50 dynamic speakers. When the magnetic type is used, the number can be increased to over 1000. We shall return to this subject in the second installment next month.

The Power Supply

The requirements for the B supply are that there shall be available 20 ma. at 250 volts. Since the type -80 rectifier can deliver up to 125 ma., it is possible to have a rather high bleeder current which will stabilize the supply. Therefore a 5000-ohm bleeder resistor is connected across the plate supply as shown in the diagram of Figure 2. The plate voltages for the three stages can be regulated individually by means of rheostats.

The filter consists of three sections, two of which are common to all stages and the third is triplicated. It will be noted that all chokes are of a rather high value. The choke in the first stage is 40 henries, the second 15 henries and the individual chokes, since they have to carry little current, are 700 henries each.

The power transformer has two different filament windings; they have both been employed to supply filament power for the amplifier. The first two stages are supplied from one winding and the push-pull stage from the other. This makes a total of seven terminals which have to be connected to the

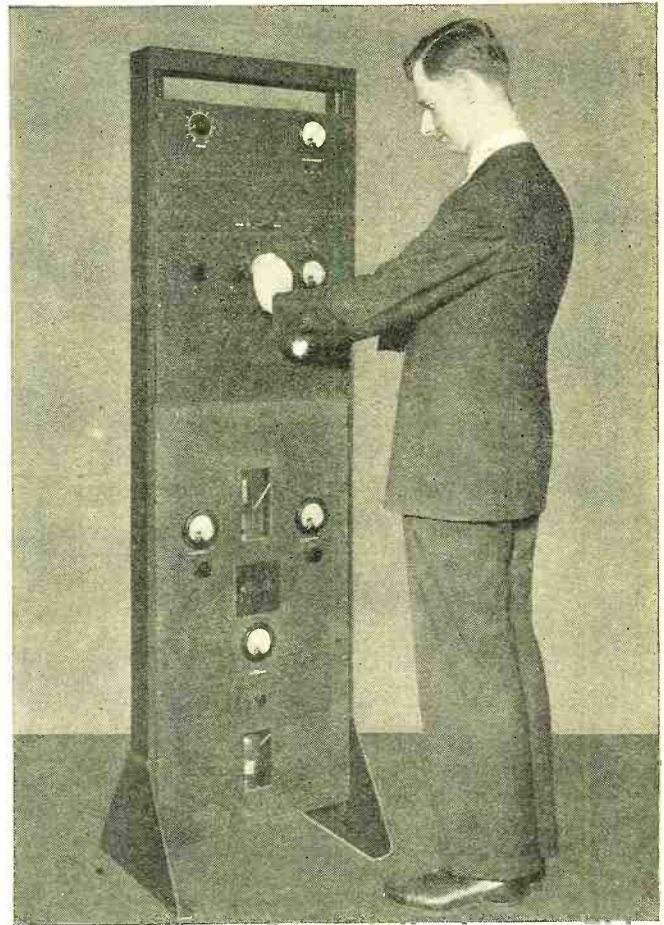

THE COMPLETE AMPLIFIER

This is the way the amplifier looks when all panels have been mounted. The plate voltage for each stage can be adjusted by means of rheostats

respective points on the previous panel. It is done with a 7-wire battery cable, plugs and receptacles, which is the only connection necessary between panels 1 and 2.

The a.c. line is connected to the transformer by a regular receptacle and a plug and cable which is interconnected with the power stage. The power is turned on at the same time with the filaments of the power stage, while the high-voltage plate supply of the power stage is controlled by a time-delay switch.

A voltmeter is mounted on the panel, together with push-button switches to connect it across (Continued on page 314)

DIAGRAM OF PANEL ONE

Figure 1. The pre-amplifier and the voltage amplifier employ the newest triodes, the type -56. Note the shunt-feed plate supply and the method of filtering the grid and bias resistors

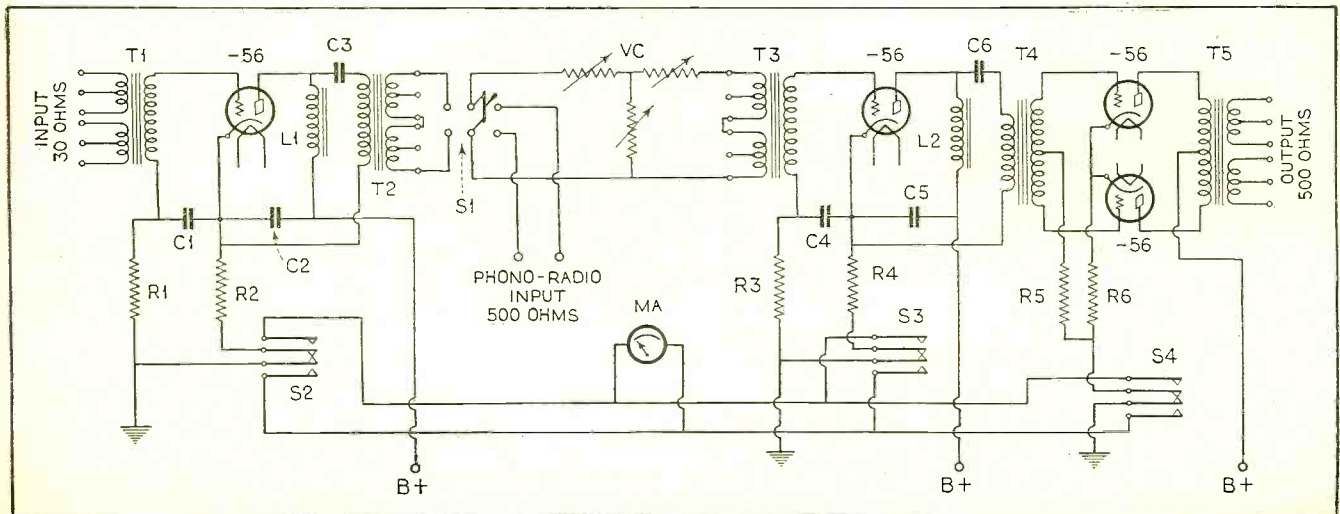

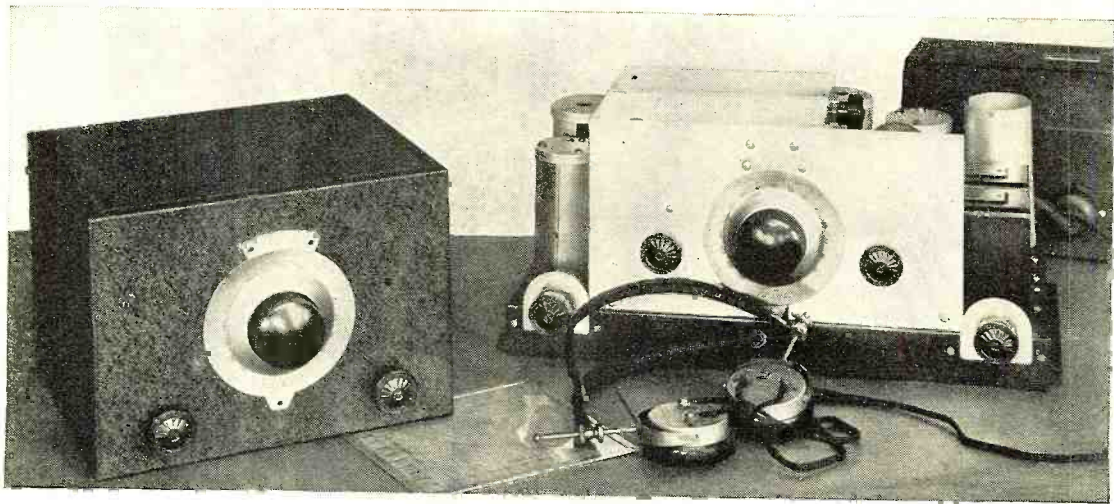

ACCURATE FREQUENCY CALIBRATION
 Figure 3. Calibrating the ultra-short-wave super described in RADIO NEWS for August. The vernier movement on the dial facilitates accurate checking and calibration

HOW THE AMATEUR CAN MAKE ACCURATE 5 Meter Measurements

By James Millen*

SINCE the first strict enforcement of the 200-meter limitation, the problem of the amateur has been the dual one of designing transmission and receiving equipment effective within the allocations assigned him, and the perfection of measuring instruments which would enable him to tune accurately within legal bands. Off-frequency transmitters have been the initial characteristic of each successive drop in wavelength, the situation becoming more and more erratic as new or lower wavelengths were opened up. Receivers were roughly calibrated against distant transmitters, presumably operating within lawful limits, to be used themselves as standards by other operators requesting "QRH?". Hardly a precise system of wavelength determination but which, in the long run, with many stations using accurate wavemeters or checking their receivers against crystal-controlled standard frequency transmitters, resulted in a natural gravitation, throughout the country, toward the centers of the 80, 40 and 20-meter bands.

This system, however, will not work on the ultra-high frequencies, due to the limited range of such transmitters. It is a case of follow the leader, with no opportunity for double checking on distant stations. The net result is that while all 5-meter transmitters operating within intercommunicating distances are tuned to approximately the same frequency, this frequency is not necessarily within the legal limits and rarely if ever coincides with the "5-meter band" employed by distant groups of intercommunicating amateurs!

The Lecher Wire as a Standard

It is probable that inexpert use of the Lecher wire system as a standard is responsible for many primary discrepancies. While this system is capable of precise measurement, when carefully employed under rigid laboratory conditions and the results interpreted by trained engineers with due consideration of correction factors, its utility for amateur purposes is as about as rough as the technique with

which it is generally handled. Inaccuracies as high as ten percent have often been noted, which, at 5 meters, is equivalent to about 10 inches along the wire. The seriousness of such a discrepancy is immediately understood when it is pointed out that a linear error of 6 inches will definitely place the frequency outside the amateur 56-megacycle band.

Frequency Meters

It is also logical to consider the possibilities of the conventional resonance indicators—the wave or frequency meters operating either on beat-note or absorption principles.

Frequency meters designed for use on the amateur 20 and 40-meter bands can be used for the accurate calibration of the 56-megacycle transmitter and receiver, due to the fact that the 5-meter band is in harmonic relationship to the lower frequency allocations. (It will be preferable, of course, to employ 20-meter oscillations in making such calibrations, due to the difficulty in discriminating among the 7th, 8th and 9th harmonics of a 40-meter fundamental.)

It is assumed that the experimenter possess a transmitter and receiver which he desires to spot somewhere within the 5-meter amateur band. To do this, the following 20-meter equipment may be employed:

1. A transmitter, preferably crystal controlled. If it is not crystal controlled, some means must be provided for determining that it is oscillating at a frequency between 14 and 15 megacycles, the fourth harmonic of which will lie between 56 and 60 megacycles.
2. A powerful local 20-meter transmitter complying with the requirements outlined above.
3. A calibrated 14,000 kc. frequency meter (oscillator) capable of generating fairly strong harmonics.
4. A calibrated 20-meter receiver, or an uncalibrated receiver which can be checked and set by a frequency meter.

The receiver employed should be of the superheterodyne type previously described. This receiver is equipped for

WIRING DIAGRAM

Figure 1. The circuit of the ultra-high-frequency meter which may be used in the direct calibration of an ultra-short-wave transmitter or receiver

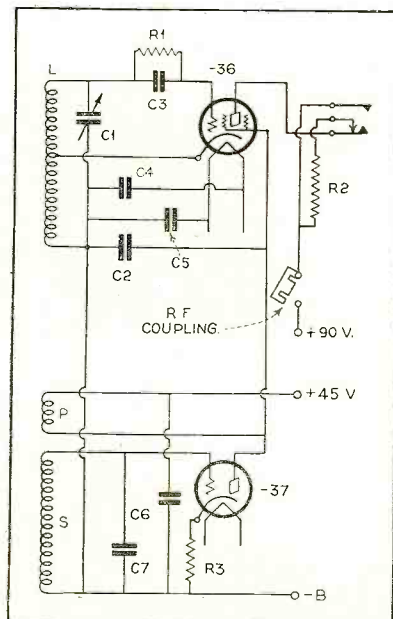

* The National Company.

beat-note reception, greatly facilitating the location of the fourth harmonic. If a super-regenerator is used it will be necessary to locate the fourth harmonic by beating with the transmitter (rather a tedious job), removing the suppressor frequency tube for the final precise zero beat.

The general method is obvious and the same for the four sources of 20-meter fourth harmonics. No difficulty should be experienced in locating the fourth harmonic from the transmitter located a few feet from the receiver. The beat-frequency oscillator on the super should now be turned off, the 5-meter transmitter placed in operation and tuned to zero beat with the 20-meter fourth harmonic.

The harmonic from the 20-meter local transmitter is utilized in the same way, and, providing the signal is reasonably strong, little difficulty should be experienced in picking it up. The procedure is exactly the same when employing the 14,000 kc. frequency meter. Several of the dynatron and electron-coupled designs are abundant in harmonics, providing probably the most direct system for calibration as well as "spotting."

The method varies somewhat when employing an oscillating 20-meter receiver. The regeneration control should be pushed up until just below the squealing point, at which adjustment the circuit is probably giving copious vent to harmonics. The 5-meter transmitter is then carefully tuned until a beat-note in the 20-meter receiver is brought down to zero. This beat-note will be caused by the fundamental of the transmitter beating with the fourth harmonic in the receiver circuit.

If any doubt exists concerning the identity of a harmonic, the fourth harmonic can always be checked against the fifth harmonic of a lower frequency. For instance, the fourth harmonic of 14,000 kc. (56,000 kc.) is also the fifth harmonic of 11,200 kc. In other words, if a harmonic is discovered at a certain point on the dial of the ultra-short-wave receiver, when the 20-meter-band oscillator is tuned either to 14,000 kc. or 11,200 kc., the receiver is tuned to 56 megacycles.

The Ultra-High-Frequency Meter

While the direct spotting of a point in the 56 mc. band is a simple and practical method of eliminating the possibility of off-frequency operation, the more scientific procedure is to design and calibrate a special ultra-high-frequency meter against which standard the transmitter and receiver may be checked and calibrated in turn. A suitable circuit is shown in Figure 1, while the photographs, Figures 2 and 3, provide general constructional details.

The frequency meter is in the form of a modulated oscillator, in which provision has been made for connecting into the oscillating circuit either telephone receivers (for direct calibration of the transmitter) or an output circuit (for direct calibration of the receiver). In either case the load circuit is electron-coupled to the oscillator and imposes no variation in the calibration of the frequency meter. Stripped to its essentials—with the modulating circuit removed and an output coil permanently substituted for the telephone jack—the design and construction can be simplified

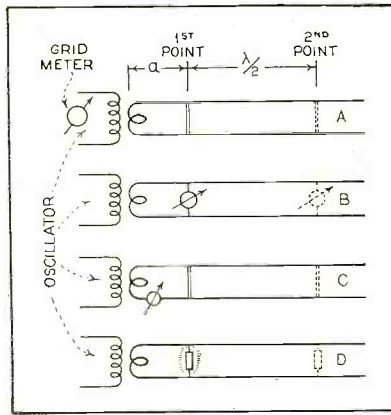

LECHER WIRE MEASUREMENTS

Figure 4. Showing several Lecher wire systems which can be used in calibrating ultra-short-wave apparatus. Distance "a" for a given frequency will vary with the system employed. These calibrations are corrected for error by any single "spot" determination of frequency

somewhat. However, in this more elementary form, the transmitter could be calibrated or checked only in conjunction with the receiver; and receiver calibration is complicated by the lack of a modulated signal.

Referring to Figure 1, coil L is wound with 2½ turns of number 14 wire on an R-39 form having a diameter of 1 inch. The tap is approximately one-third the way from the low-potential end. Coils P and S are respectively the primary and secondary of an audio-frequency transformer with the core removed.

Condenser C1 is the National ultra-short-wave type and has a capacity of 12 mmfd; C2 and C3, .0001 mfd.; C4 and C5, .01 mfd.; C6, .1 mfd., and C7 varies from .01 to .1 mfd., depending on the constants of the transformer coils and modulation note desired.

R1 is a grid leak having a value of 5 megohms, while R2 has a d.c. resistance equal to that of the phones.

The potentials and tubes used are indicated on the diagram.

Calibration can be most readily secured from a lower frequency source by means of a 20-meter-band receiver checked against an accurate 14-megacycle frequency meter.

The output of the meter is coupled to the input of the receiver by means of a small coil—five turns of wire on a 1½-inch form—connected to the "r.f. coupling" posts. Coupling should be just close enough to insure satisfactory pick-up. Detector regeneration is turned up so as to secure an adequate supply of harmonics and the frequency meter adjusted for zero beat with the fourth harmonic of the receiver. (The headphones are, of course, plugged into the 20-meter set.)

Any of the other methods outlined above for the calibration or spotting of the 56-megacycle transmitter can be used for the same purpose on the frequency meter. The frequency meter is coupled to the receiver in the manner described in the preceding paragraph.

Where complete calibration is not feasible due to lack of calibration in the 14 mc. band, recourse can be made to the Lecher wire system, providing one definite frequency can be spotted accurately.

Calibrating by Lecher Wires

While, as we have pointed out, direct calibration by means of Lecher wires is not to be depended upon, for more than a rough determination of wavelength, the percentage error remains practically constant over the restricted frequency range encompassed by any single band. Therefore, if one spot on the dial can be accurately associated with a certain frequency by any of the methods previously considered, the error of the Lecher wire measurements can be established and calibration curve consistently corrected.

The system of Lecher wire measurement is familiar to most experimenters. It consists, roughly,

in extending from the source of oscillations a pair of wires at least one wavelength long and measuring on them the half-wavelength distance between adjacent maxima or minima of current or voltage in the standing waves.

We have found that the most reliable of the simple Lecher wire systems consist of two wires [number 12, (Continued on page 312)]

TYPES OF FREQUENCY METERS

Figure 2. (Right) Frequency meter with self-contained "B" supply. Figure 5 (Left) Absorption type wavemeter used for rough and reasonably fine checking

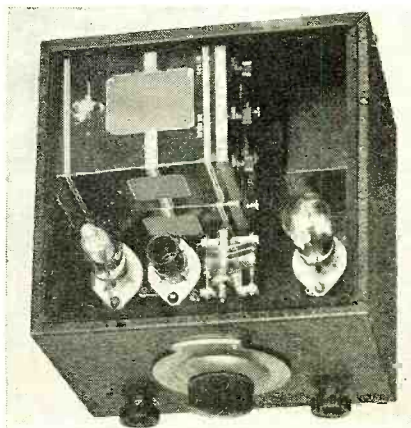
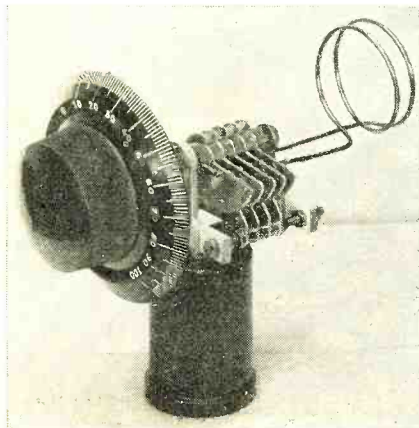

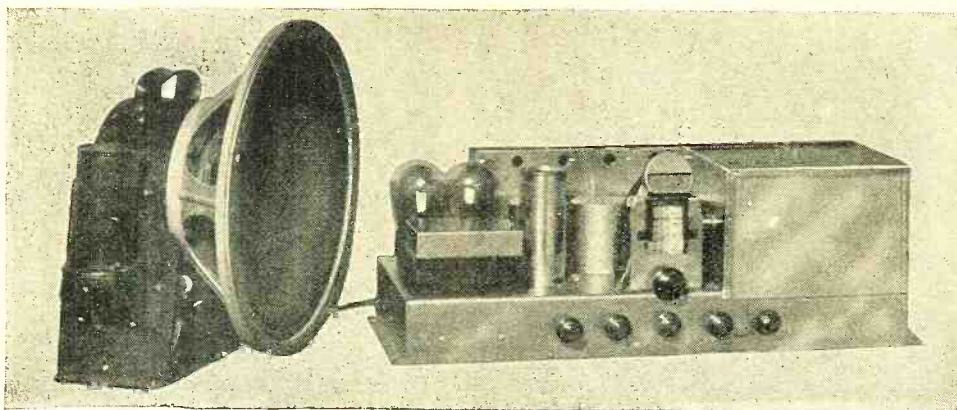

Reception Tests of a New **Laboratory-Built Super**

*Herein are presented the results of tests of this receiver, carried on in
Chicago and the East by the Laboratory staff*

AS this report deals with a new receiver which has not been described in RADIO NEWS, some information on it will not be out of place. The set itself is essentially the Silver-Marshall 728-SW twelve-tube superheterodyne described in the September, 1932, issue. But it is custom-built and inspected all the way through, and has a higher degree of sensitivity than the 728-SW, with 10 kc. selectivity and undistorted power output of just over 8 watts. Fidelity is guaranteed flat to 4 decibels from 40 to 4000 cycles. The chassis itself is finished in lacquered brass and is most pleasing and attractive to the eye.

The loudspeaker used is a special high-efficiency unit such as is used in movie theatres and for P.A. work. For a dynamic unit, its frequency characteristic is unusually free from bumps and valleys, and is flat to plus or minus 5 decibels from 3 to 1000 cycles and then rises to plus 10 decibels at 4000 cycles, tending to give additional brilliance to high-frequency tones and offset such sideband cutting as does occur. But it especially shines in efficiency—the electrical to sound conversion efficiency of the average dynamic unit is about 5 percent, while this special unit is said to have a 15 percent conversion efficiency. This means that it will turn out three times the power that an ordinary smaller unit will turn out. This speaker increases the power output of the CB-1 receiver until it sounds like 24 watts out of an ordinary speaker, while the tone is excellent.

Some idea of the size of this speaker can be had from the photograph. It has a 12-inch cone, 14-inch cone frame, and a tremendously large field magnet—both in wire and iron (it's weight is over forty pounds!). Its maximum volume is too great for home entertainment, yet the reserve power tends to give a depth and brilliance to home reproduction, since there is really ample power available for musical crescendos at dancing volume level for home or ballroom.

Because of this power an especially solid cabinet is necessary. Such a cabinet has been designed especially for the CB-1 receiver. It is a combination of exceptionally well-finished American and Oriental walnuts and is 46¼ inches high, 27¼ inches wide and 14¼ inches deep. Some idea of its solidity and excellent baffling characteristics can be gained from its weight, which is 38 pounds without chassis and speaker.

One of our staff, making a brief stop-over in Chicago, had the opportunity to make the first field test of the new CB-1 receiver. Following are quotations from his report:

"Yesterday, in Chicago, I was out at the Silver-Marshall

Laboratories. We went down into the plant, took one of the new CB-1 receivers that had just been okayed and drove out to a home in the Chicago suburbs, about twelve miles from the Loop. We hooked it up to the antenna already installed and immediately brought in 12RO, Rome, Italy, clearly and with an unusual lack of noise.

"We tuned the dial slightly and got G5SW, Chelmsford, England, with almost identical volume, although it was fading much more than 12RO. Just below that we brought in FYA, Pontoise, France. We tuned the set back, re-identified each station and then enjoyed the opera broadcast from 12RO for an hour. The clarity and volume, particularly with respect to the amount of noise, were the outstanding features of the demonstration.

"At 6:00 o'clock we turned to G5SW again and heard the Big Ben chimes sounding the twelve strokes of midnight, and the sign-off. The fading was a little worse then, but we could hear the twelve strokes with such volume that they could in all probability have been heard a block away. I wanted to hear FYA sign off with the Marseillaise, but unfortunately when we tuned back to them they were already off the air.

"Later we brought in a number of short-wave stations in the western hemisphere—including a number of Spanish-speaking stations and several Canadians as well as a lot of aeroplanes, amateurs and police 'phone work.

"We found the receiver to be very sensitive and selective on the broadcast band, giving us with one turn down the dial the choice of 56 broadcast programs with good reproduction, although a storm was brewing that simply blocked out many channels, it was so noisy. But the more powerful stations throughout the country came in, many with great volume. That storm, by the way, broke soon after that and made everything pretty nearly impossible except the Chicago locals.

"I could not stop over in Chicago long enough to try the set around 5:00 o'clock in the morning to check the quality of VK3ME (Australia) and make a try for some of the Oriental short-wave stations, but from the way it performed on 12RO (and you could easily dance to the music if you want to dance to opera), I think it would have given a good account of itself.

"I believe that the results with this set would have been a little better had we been using a decent antenna. The one we used was about 75 feet long and strung from the house down a little slope to the garage. It was well below the top of the house (two-story) and considerably under the tops of the surrounding trees, and the lead-in wasn't so good for short

By
S. Gordon Taylor
and
William C. Dorf

waves, coming down for 30 feet to the first floor, right up against the house itself.

"One thing about the set that I couldn't get quite used to was its extreme sharpness in tuning. It was particularly sharp on the last high-frequency band where the European reception was heard and required extremely careful tuning. However, due to the fact that the dial is calibrated individually for each wave range and appears to be very accurate, the tuning is simplified to such an extent that this sharpness is not a serious objection. On the broadcast band the selectivity was ample, bringing in WOR very clearly between local WGN and WLW. By the way, just after we turned the set on, at about 4:30 in the afternoon, we got Windsor, Canada; Davenport and Watertown, Iowa; Kansas City and Cincinnati quite well on the broadcast band, and, of course, the whole gamut of domestic short-wave stations that were on."

At this time arrangements were made to ship a receiver to New York immediately, in order that tests would be conducted there.

The set arrived in the editorial offices in New York City on August 19th and was transported by car the following day to Fairfield Beach, Connecticut. This is a summer colony five miles from Bridgeport and about fifty miles from New York City.

On arrival in Fairfield, the operating test got under way about 8:45 p.m., too late for reception from most European stations. However, there was still some time to tune in EAQ, Madrid, Spain, just before they signed off at 9 p.m. This station was tuned in and with such volume that the listener could hear the English announcement 50 feet from the house. The automatic volume control was a most desirable adjunct, as it held EAQ to a substantially constant level of volume for the full 10 minutes they were on the air.

The American short-wave stations W8XK, 6140 kc., and W2XAF, 9530 kc., and the Canadian stations, VE9GW, 6095 kc., and VE9JR, 11720 kc., were easily obtained, as were numerous police calls, international 'phone stations and amateur

calls on their assigned wavelengths.

Leaving the short waves, the extreme selectivity and sensitivity of the receiver for broadcast reception was immediately demonstrated, as signals were received on practically every assigned broadcast channel. The infrequency of call announcements of the stations prohibited any attempt to identify all the stations that were tuned in. However, all stations between WSM, Nashville, Tennessee, operating on 650 kc., and WBBM, Chicago, Illinois, on 770 kc., were definitely identified, with the exception of the 680 kc. channel, which is occupied by station KPO, San Francisco, California, rarely heard in this location during the summer months. Also a few at the top and bottom of the dial, to check the frequency calibration of the dial, which was found accurate to less than 2 percent.

At 12:45 a.m. a try was made for the West Coast broadcast stations, and KFI, Los Angeles, came in with good strength and with but little fading. Earlier, stations WBAP, Dallas; WHO, Des Moines; and WFIW, Hopkinsville, Kentucky, were received with excellent volume and low noise level, among those whose call letters were heard.

The next day the short-wave tests were continued and signals were received from Zeesen, Germany; EAQ, Spain, and the three principal short-wave European stations, G5SW, England; FYA, Pontoise, France, and 12RO, Rome. In general, the European reception this day was only fair. Fading was very much in evidence and signal strength relatively low. Occasionally such a day occurs, and it was our luck that such should be selected as a test period.

Tests in New York City

The antenna employed for these Fairfield tests was a single wire of 50 feet with a lead-in measuring 15 feet, and the ground connection about 20 feet.

The next operating tests were performed in an apartment house situated approximately five miles from the heart of New York City. A comparison check (*Continued on page 313*)

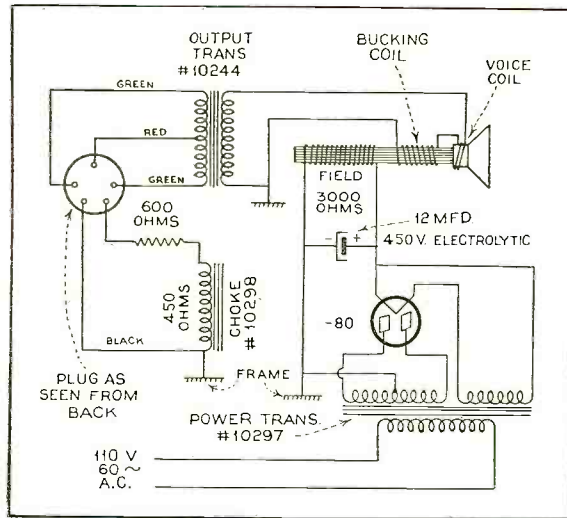
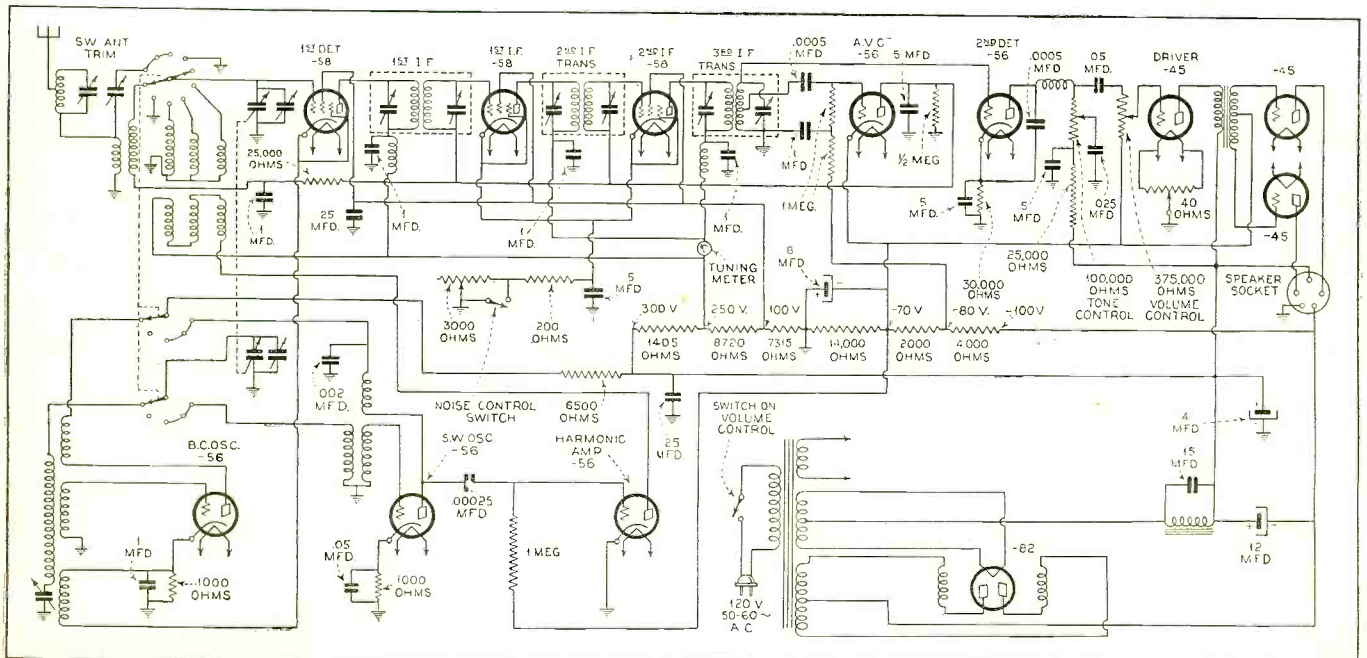

DIAGRAM OF NEW LOUDSPEAKER UNIT

Figure 2. This new auditorium type speaker is unusually efficient. It contains its own power supply, utilizing an -80 type tube

THE CIRCUIT OF THE CB-1 RECEIVER

Figure 1. This circuit is almost identical to the 728 SW receiver described in the September issue



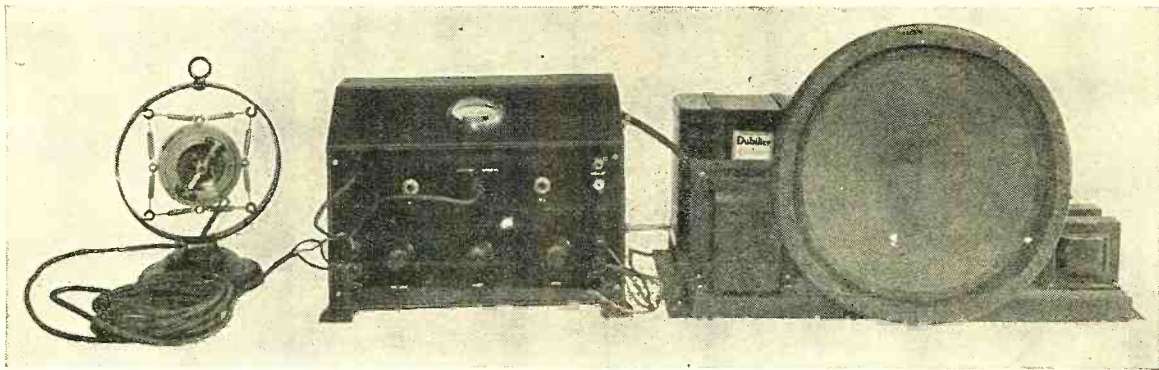

The "Election Special"

A Low Cost Public Address System

In meeting the constant demand for inexpensive P. A. equipment, the combination described here fills a long-felt need.

WITH the 1932 presidential election at hand, the thoughts of the radio experimenter and serviceman turn to public-address systems and amplifiers. With millions of words being thrown at prospective voters, both through broadcast stations and public-address systems, the call for voice amplification is tremendous. From the cities with their millions to the smallest hamlet, political orators will cry their "wheres and whyfores."

The drawback to the average serviceman in owning a public-address system has been the high initial cost of building one. Three-stage amplifiers with dynamic speakers, tubes and microphones, run anywhere from \$100.00 to \$1000.00. The Election Special enables one to assemble and build a complete P.A. system with a three-stage amplifier and dynamic speaker for a fraction of this minimum cost.

The ridiculously low cost of the main components of the equipment described here is readily explained. Immediately after the introduction of electrically operated receivers, commercial receiver manufacturers found themselves with a large

By Nat Pomeranz

stock of battery-operated receivers which, due to the demand for electric receivers with dynamic speakers, were a total loss.

Hence, the birth of the 210 power amplifier and dynamic speaker with a built-in B supply for the battery receiver, giving an "electrically operated" twist to the battery receivers. So many of these units were manufactured and placed upon the market that the supply exceeded the demand. As a result, even today these amplifiers and speakers are being sold as surplus material by mail-order houses and stores for well under \$10.00. It is around one of these units that the P.A. system here described has been designed.

This article deals with the construction of a pre-amplifier unit consisting of two stages of audio-frequency amplification with the necessary controls for microphone current, gain, microphone and phonograph mixing, etc. This pre-unit, coupled into the 210 amplifier and dynamic speaker unit mentioned above, produces a good strong signal from voice or records. Because the Kolster K-5 210 amplifier and dynamic speaker was one of the most popular in its time and due to the fact

THE SCHEMATIC CIRCUIT OF THE COMBINED UNITS

Figure 1. At the left is shown the circuit of the pre-amplifier, including all necessary controls. The circuit of the Kolster K-5 power speaker is shown at the right

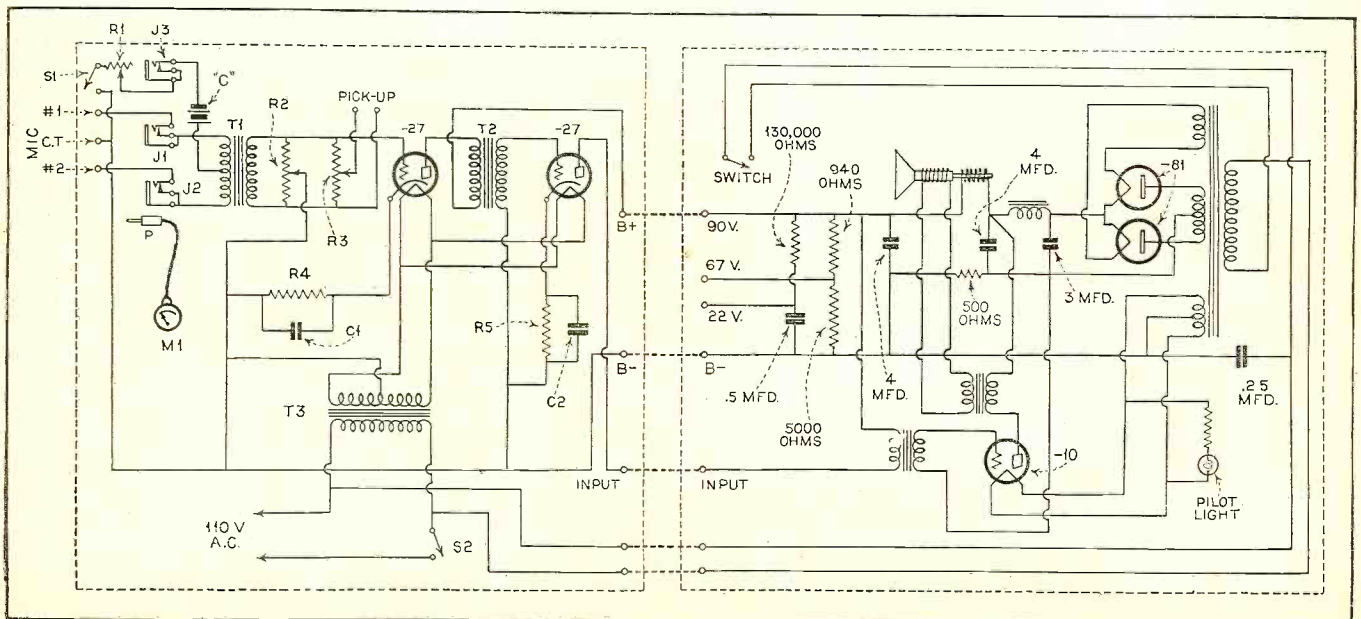

that there is a plentiful supply available, we will use this as our power stage and speaker.

This does not necessarily lead to the thought that any other type of amplifier is barred from being used. On the contrary, our pre-amplifier unit is constructed so that it can be hooked directly into an audio transformer primary of any type of amplifier, either single or of the push-pull type, with the only requirement that a B voltage of at least 90 volts can be tapped from the power supply of the power unit to activate the plates of the two -27 tubes used in the pre-unit of the device.

The cabinet for this unit can be made of three-ply panelling or any other type of wood that has a thickness of at least one-quarter of an inch. Wood having a thickness of at least one inch is used for the base. It is really immaterial how or with what this cabinet is built, because it cannot ultimately affect the working of the outfit. However, in order to comfortably house all the parts required and still have space left in it for a 4½-volt C battery which will activate the microphone, it must be at least 11 inches in length, 7 inches in width and 8 inches high.

As shown in Figure 2, the cabinet is not just a four-cornered box but has a sloping top to permit the placing of the microphone current meter on this panel, where it can easily be seen from either above or in front. This was originally done because it is not very often that a pre-unit of this type, when in use, is placed on a level with the operator's eyes. It usually rests on a table beneath him.

The flat-top portion of the cabinet, measuring 3¼ inches by 11 inches, is placed upon hinges so that the C battery and tubes are accessible.

Figure 3 shows the layout of the front panel, which can be cut to fit the opening for the cabinet after it is completed.

Wiring the Unit

Starting with the three binding posts at the left of the front panel, care should be taken that, in wiring, the middle binding post is always used as the center-tap of the microphone, with the other two posts serving the two button connections. For the sake of expediency, we will designate the two buttons No. 1 and No. 2 and the center-tap of the microphone as "CT." Binding post No. 1 is wired to one side of the jack, J1, with the other side of the jack going to one side of the

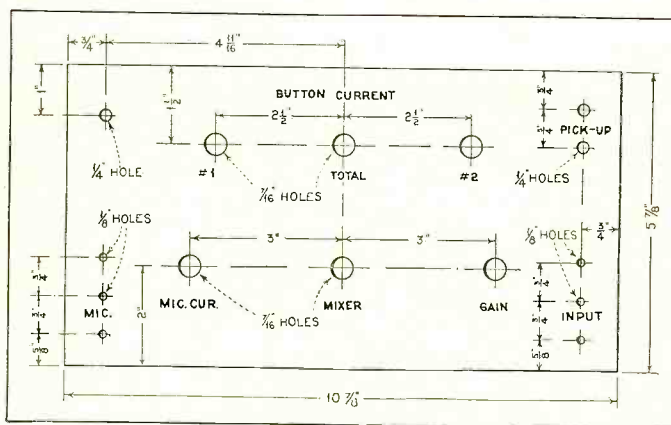

FIGURE 3. PANEL LAYOUT

tap of the microphone transformer.

The phone jacks should be wired so that when the plug is not inserted in any of them they short through as if no jack were in the circuit. J3 shows the total microphone current, while J2 and J3, when the plug which is connected to the 0-25 milliammeter is inserted in either of these two, show the current on the individual buttons. In wiring this part of the circuit, be sure to wire the jacks with correct polarity.

R2 is a potentiometer, connected directly across the secondary of the microphone transformer, with the movable arm going to the filament side of the first -27 tube or cathode. This variable resistor acts as a gain control on the output of this pre-amplifier.

R3 is another potentiometer, but is used as a fader or mixer. Here, too, both sides of the control are connected across the secondary of the microphone transformer, with the movable arm going to one of the tip-jacks for the phonograph pick-up. The other jack is connected to the open side of the transformer secondary.

The builder of this unit will have to figure out for himself which side of the control to make filament-ground and which side grid in order to have the control work right. When the knob of the control is turned completely to the right, only phonograph music will be heard; when turned completely to the left, only voice from the microphone. Somewhere in between, the happy medium will be reached where both the phonograph and the voice blend in their proper ratios.

Any make of filament transformer (T3) can be used that will deliver 2.5 volts for at least two -27 tubes. A center-tap is not absolutely essential, but, where possible, it should be grounded.

The audio transformer (T2) should have a ratio of 3 to 1. In this part of the circuit it does not (Continued on page 304)

TOP VIEW OF PRE-AMPLIFIER

Here the cover is left open to show internal layout. The filament transformer is seen at extreme right

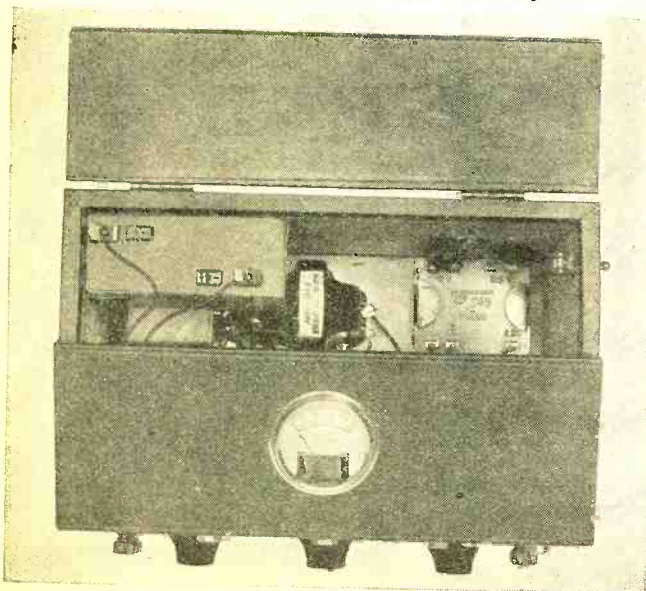

INSIDE VIEW OF PRE-AMPLIFIER

The control panel has here been detached and dropped to show placement of parts on base of cabinet

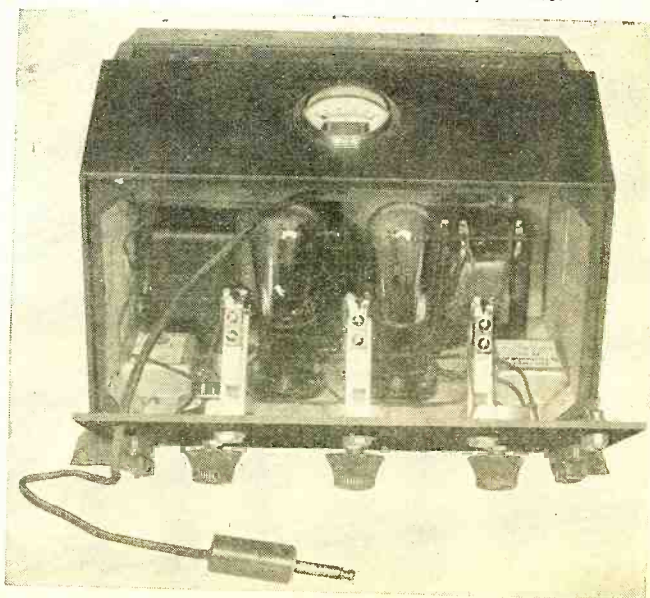

The Pocket Diagnometer

Introducing Point-to-Point Analysis

This tiny universal meter unit provides a complete variety of d.c., a.c. and resistance measurements. Combined with a small switching unit to be described next month, it makes an unusually complete set analyzer

THERE are three main electrical components with which the serviceman has to deal in his daily work, namely: voltage, current and resistance. In the past, resistance has been too much neglected and too much dependence has been placed on voltage and current readings in analyzing troubles in radio circuits. The more progressive servicemen who have been giving resistance measurements their due consideration have been prone to make use of resistance-measuring equipment distinct and separate from the set analyzer unit.

By D. L. Van Leuven
Part One

The new equipment to be described in this and a second article to follow next month, marks a decided advance in measurement and testing apparatus. Looking at the illustrations, one would think that its small size would limit its utility, but, surprising as it may seem, this tiny test outfit will do just about any job that the serviceman or experimenter requires, and will do some things that larger and far more expensive outfits cannot accomplish. Not only will it make all the usual voltage and current measurements required of an analyzer, but it will also make measurements between any two points in any receiver tube circuit. In addition, it will make accurate resistance measurements in any tube circuit, or between points in different circuits.

Two Compact Units

This equipment is unique in another respect, in that it consists of two units. The first unit constitutes a complete, self-contained universal meter with a direct-reading scale for various ranges of voltage and current and resistance measurements. This is the unit which will be described in detail this month.

The second unit includes the circuit selector switches and cable-plug assembly necessary to convert this universal meter to set analysis purposes. When used together as analyzer, the selector unit is strapped onto the meter unit by means of bus connectors bridging across from the three terminals at the top of the meter to three corresponding terminals on the selector, as shown in one of the photographs. Figure 1. If desired, the two units may be combined in one case, and for the serviceman such an arrangement, with a t.p.d.t. switch in place of the bus connectors, would probably be the most logical. For the experimenter who only occasionally requires the use of an analyzer but who has constant use for a universal meter, the plan of making up the equipment in the form of two units will be most practical.

The meter box is only 7 inches long and 4½ inches wide—just large enough to provide adequate panel surface to accommodate the Weston Universal a.c.-d.c. meter, two range-selector switches and the three connection terminals. The depth is sufficient to provide ample space for the various multiplier and shunt resistors, the C battery and the rheostat used to obtain zero adjustment for resistance measurements.

The Meter Unit

The unit provides five current ranges, five voltage ranges and three resistance ranges, the voltage ranges providing for both d.c. and a.c. measurements. These ranges are: Voltage—5, 10, 50, 250 and 1000; current—1, 5, 10, 25 and 100 milliamperes; resistance—1000, 10,000 and 100,000 ohms.

The special dial available for the meter is calibrated in three ranges

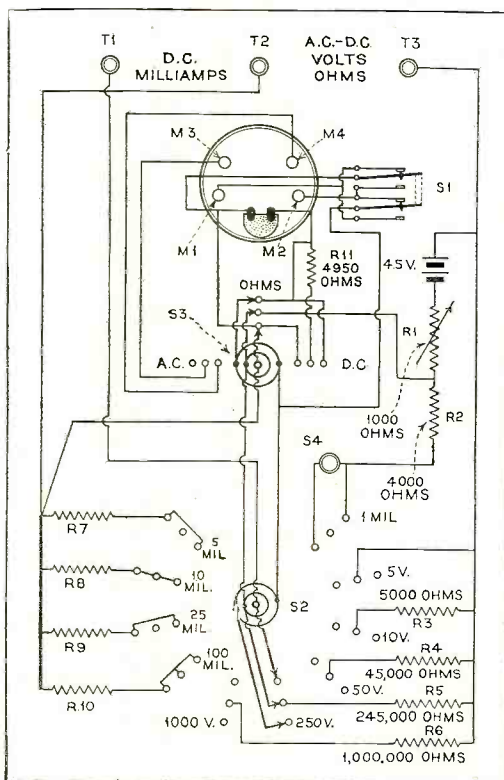

THE WIRING DIAGRAM

Figure 5. The symbols used here are repeated in the accompanying photographs, thus showing the actual location of all parts in relation to the circuits

CLOSE-UP OF THE METER

Figure 2. (Left) The meter provides five voltage ranges (a.c. and d.c.), five current ranges and three resistance ranges; all direct reading

UNDER VIEW OF PANEL

Figure 3. (Right) In spite of its small size, the parts are not unduly crowded

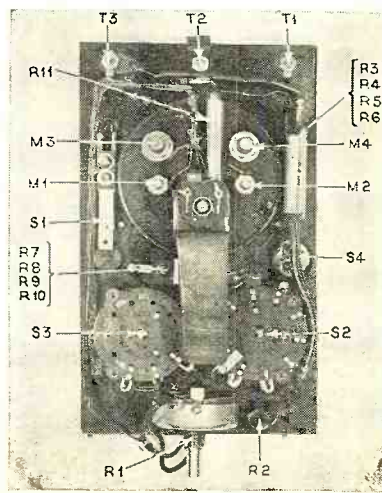
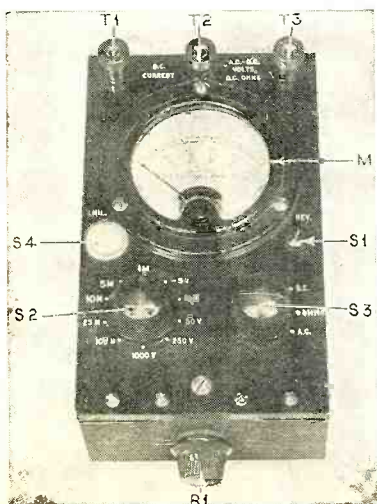

for current and voltage readings, 0-50, 0-250 and 0-1000, and in one range (0-100,000) for resistance. Thus the three voltage ranges corresponding to the calibration ranges are read direct while all other measurement ranges are read by simply pointing off decimals on the calibrated ranges. This eliminates all necessity for calculations—the bugbear of many combination meters. If one wishes to resort to calculations, additional intermediate resistance ranges may be used in addition to the three mentioned above. Resistance measurements are made with the range selector switch set for the 1 ma., 10 ma. or 100 ma. ranges, depending upon whether the 100,000, 10,000 or 1000-ohm ranges are desired. By connecting together the 3 points of the 5 ma. section of S2, and the same with the 25 ma. section, additional resistance ranges of 20,000 and 40,000 ohms, respectively, are obtained.

Selector Switches

The meter box includes two rotary switches. One of these, SW2, is of the ten-pole type and serves as the range selector, providing the five current ranges and five voltage ranges, the current range settings serving for the resistance measurement ranges also, as explained above. The other switch, SW3, provides for the type of measurement desired—a.c., d.c. or resistance. There is also a polarity reversing switch, SW1, and a push-button safety switch, SW4. The latter is in the circuit only when the 1 ma. range is in use and is provided to safeguard the meter, the assumption being that the necessity for pushing the button when using this range will serve as an automatic reminder that due care must be exercised to avoid overloading the meter.

Terminals T1, T2 and T3 provide connections for test prods, terminals 1 and 2 provide connections for all d.c. current measurements, while terminals 2 and 3 provide connections for voltage and resistance measurements. These three terminals take the form of binding posts which are designed to accommodate spade tips, phone tips, wire tips or plugs.

On the front side of the box is a knob which controls a rheostat, R1, connected in series with the internal flashlight battery and used in making resistance measurements. In operation, the switches are set for the resistance range wanted, then this rheostat is adjusted until the meter shows full-scale deflection with T2 and T3 shorted. This arrangement has the advantage that the voltage of the flashlight battery is not critical, because dropping voltage can be compensated for in the rheostat.

From the foregoing it is evident that the operation of this combination meter is simple and without complications of any kind, in spite of the surprisingly wide variety of purposes which it serves.

As to the design and construction details, this

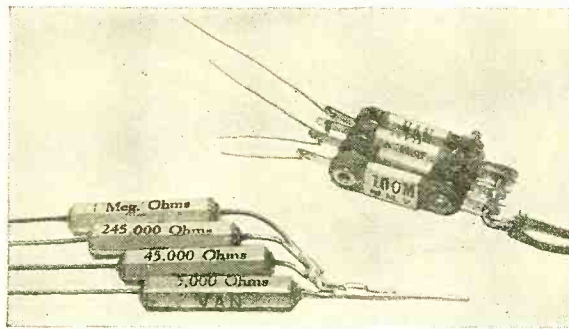

THE RESISTOR ASSEMBLIES

Figure 4. The resistors are assembled as shown before they are installed. This facilitates wiring and makes for compactness

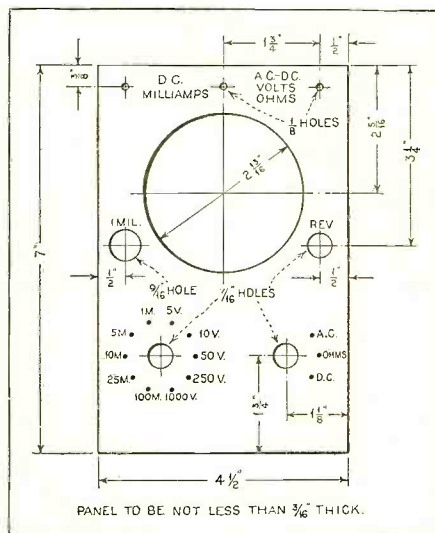

THE PANEL LAYOUT

Figure 6. Complete drilling and engraving specifications are shown here

meter unit differs from the vast majority of other combination meters in that shunts are used across the meter itself for all current measurements. Most other popular combination meters employ a combination of multipliers and shunts for this type of measurement. That is, instead of providing shunts across the meter alone, they shunt both the meter and a multiplier resistance; or, another way of saying it is that they measure the voltage drop across a resistor of a hundred ohms or so, this drop being caused by the current under measurement flowing through this resistor.

The disadvantage of this common system is that the 100-ohm resistor in series with the circuit in which the current is flowing increases the overall resistance of some circuits sufficiently to materially alter the current flow, particularly in low-voltage circuits, and therefore make measurements inaccurate.

Direct Shunts Employed

The advantage of the direct shunt is most important because it means that the meter under discussion here can be used for all d.c. current measurements, whereas the ordinary types of combination meters can be used accurately only in measuring currents in relatively high-resistance circuits.

Both the shunts and the multiplier resistors used in this unit are highly accurate. In fact, they are more accurate than the meter itself, which means that the completed combination unit is limited in its accuracy only by that of the meter itself. The shunt resistors, incidentally are, especially made for use with this meter. Van shunts and multiplier resistors are available in values other than those employed in this particular unit. The constructor can, therefore, add other voltage and current ranges if he so desires, or substitute other ranges for those specified in this article.

The method of assembling and mounting the parts is made quite clear in the accompanying photographs. Figure 6 shows the layout, and if this layout is followed, the correct position of external parts will be automatically located.

THE METER-ANALYZER IN OPERATION

Figure 7. Comparing the combination meter and analyzer unit with the midget receiver (and it is a small midget) conveys a good idea of the unusually small size of the meter unit

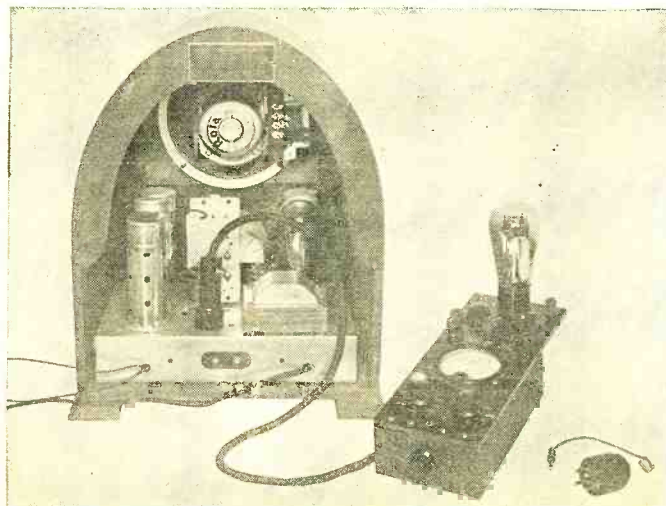

The shunt and multiplier resistors should be first assembled in two units, as shown in Figure 4. The group of four shunt resistors (R7, R8, R9 and R10) are connected together at one end with heavy wire. Short individual leads are soldered to the other ends. These four leads may then be soldered to the proper terminals of the switch SW2 before mounting the latter on the panel. Be sure that these four connections are kept short; otherwise the resistance of the wire may be sufficient to effect the accuracy of the shunt values. This is particularly true of the 100 ma. shunt. It is equally important that the switch contacts be absolutely clean; otherwise they too may introduce undesirable (Cont'd on page 305)



Radio Science Abstracts

Radio engineers, laboratory and research workers will find this department helpful in reviewing important current radio literature, books, Institute and Club proceedings and free technical booklets

Communication Engineering, by W. L. Everitt. McGraw-Hill Book Co. 1932. This is a textbook on the fundamental principles of electrical communication both with and without wires. A great number of men employed in the radio industry have limited their study to radio communication and have neglected to consider that the industry has borrowed heavily from the telephone art. Such men are often hazy on subjects which are not covered in the average radio textbook. Impedance matching, filters and networks are three representative examples of these subjects. For this reason, Mr. Everitt's book should be of special interest to engineers, students, amateurs and experimenters.

The theory of transmission lines, filters, reflection and impedance matching is treated in the first part of the book. The reader will find in this part the fundamental information he needs for the design of his own apparatus.

Another interesting part is the chapters on electro-mechanical coupling and on radiation. Electrical laws can be employed in mechanics if the proper equivalents to electrical concepts are first defined. The design of a unit then becomes a matter of impedance matching and can be expressed by a variation of Ohm's Law.

There are, of course, the usual chapters on resonance, coupled circuits, tubes, amplifiers, detectors and oscillators. The final two chapters briefly discuss r.f. measurements.

A knowledge of mathematics, including calculus, is desirable for the understanding of the text. However, the greatest part of the text does not use advanced mathematics and other subjects are first explained before equations are introduced. The reader will find a discussion on the application of algebraic methods of solving alternating-current problems with the same laws as those for direct current. The use of hyperbolic functions is also treated before their application is introduced.

Advanced Course in Radio Servicing and Merchandising, National Radio Institute. This course consists of the following lessons:

- 1RA. Installation service.
- 2RA. Radio servicing in the home.

Conducted by Joseph Calcaterra

- 3RA. Testing with meters at the work-bench.
- 4RA. Testing vacuum tubes.
- 5RA. Testing sound-reproducing devices.
- 6RA. Bench servicing of power packs and other sources of power.
- 7RA. Bench servicing of a.f. equipment and power amplifiers.
- 8RA. Bench servicing of r.f. equipment.
- 9RA. Testing receiver parts.
- 10RA. Testing power-supply parts, by-passing and filtering.
- 11RA. Internal receiver noises.
- 12RA. Receiver hum.
- 13RA. External receiver noise.
- 14RA. Radio drafting and blueprint reading.

- 15RA. Special radio installations.
- 16RA. Acoustics in the home. Superhetrodyne troubles and remedies.

Special test No. 1. The store—Its location, equipment and personnel.

Special text No. 2. The art of buying radio merchandise.

Special text No. 3. Radio advertising and merchandise display.

Special text No. 4. Instructions in selling in the retail field.

With this advanced course the following three supplementary reference texts are included:

9SB. Radio Mathematics. The use of arithmetic in radio.

10SB. Radio Mathematics. The use of algebra in radio.

11SB. Radio Mathematics. The use of geometry in radio.

12SB. Radio Mathematics. The use of trigonometry in radio.

This course contains a wealth of information concerning both the technical and the commercial side of service work. Testing instruments and how to make and use them is fully covered in the appropriate places. For instance, in the lesson on tube testing one finds the measurements of amplification constant and mutual conductance fully explained. There is sufficient information to

enable the student to build his own bridge for these measurements.

The lessons describe, systematically, all the troubles the serviceman is likely to encounter and how to locate them. A very interesting part of the course is the description of apparatus to measure sensitivity, selectivity and fidelity of receivers as well as the gain of amplifiers. Practical information on how to handle the equipment is given in detail.

Aside from his technical knowledge, the success of the serviceman depends on his business ability and his behavior in the home of the customer. The first two lessons pay special attention to work to be done in the home of the set owner.

The four lessons dealing with merchandising should be helpful to the man who wishes to go into the radio business. Valuable advice on buying, store management, advertising, etc., is to be found in this part of the course.

Sound Re-Recording, by Kenneth Lambert. Technical bulletin of the Academy of Motion Picture Arts & Sciences. Supplement No. 9. July 20, 1932. A short article on the aims and problems of re-recording. The author tells why it is desirable to re-record the whole of a reel in order to have the same quality throughout as well as to introduce accompanying music and sound effects.

Review of Articles in the August, 1932, Issue of the Proceedings of the Institute of Radio Engineers

Recent Trends in Receiving Tube Design, by J. C. Warner, E. W. Ritter and D. F. Schmit. A summary of the important developments in the receiving tube field during the past ten years, with special reference to the use of suppressor grids and improvements in cathode and grid design. The development of the Class B amplifier and mercury-vapor rectifiers is also included.

Analysis and Reduction of Output Disturbances Resulting from the Alternating-Current Operation of the Heaters of Indirectly Heated Cathode Triodes, by J. O. McNally. A discussion of the elements and

factors which produce noise and other disturbances in indirectly heated cathode triodes and the manner in which these factors and disturbances can be counteracted, is given in this paper.

Modern Radio Equipment for Air Mail and Transport Use, by A. P. Berejkoff and C. G. Fick. This paper discusses the requirements of this type of aircraft equipment and describes the mechanical and electrical features of specific equipment.

Planning the NBC Studios for Radio City, by O. B. Hanson. This paper gives some interesting data on the considerations which determined the size and physical layout of the studios and equipment for Radio City.

A New Type of Ultra-Short-Wave Oscillator, by I. E. Mourontseff and H. V. Noble. This paper describes a new oscillator in which the conventional tank-circuit is replaced by a portion of concentric transmission line. The limitations of conventional tubes and circuits in the production of ultra-short waves, below 8 meters, and the factors which must be considered in designing efficient tubes and circuits for ultra-short-wave oscillators are discussed. The biological effects of ultra-short waves and their possible application to therapeutic, physiological and biological problems are also considered.

The Action of Short-Wave Frame Aerials, by L. S. Palmer and L. L. K. Honeyball. The importance of the physical size of a frame or loop aerial on its efficiency in receiving short waves is discussed in detail in this paper. The fact that tuning alone is not sufficient to bring in the signal at maximum strength is brought out by comparative data on the increase or decrease of signal strength which takes place as the size of the aerial is changed, even while the aerial is kept tuned to a given wavelength.

A Simplified General Method for Resistance-Capacity-Coupled Amplifier Design, by David G. C. Luck. The information and curves given in this paper are worked out to simplify the design of the amplifiers mentioned and to eliminate the tedious calculations usually required to properly design such amplifiers for given applications.

Review of Articles in the June-July, 1932, Issue of the Journal of the Institute of Radio Servicemen

The Problem of Continuity Testing in Radio Service Work, by John F. Rider. This paper traces the development of continuity testing for resistance and capacity in

Review of Technical Booklets Available

1. *1932 Fixed-Condenser Catalog*. A 12-page booklet giving complete specifications and list prices on Micamold dry electrolytic, paper, mica and replacement condensers, automobile ignition suppressors and carbon resistors.

2. *1933 R.F. Parts Catalog*. An 8-page folder containing complete specifications on the entire line of Hammarlund variable and adjustable condensers, r.f. transformers, sockets and shields for broadcast and short-wave receivers.

4. *15 to 200-Meter Comet "Pro" Superheterodyne*. A booklet which gives the outstanding features of the Hammarlund-Roberts high-frequency superheterodyne designed especially for commercial operators, for laboratory, newspaper, police, airport and steamship use.

5. *1932 Variable and Fixed-Resistor Cat-*

alog. Complete specifications on the standard line of volume controls, voltage dividers, replacement resistors, fixed and adjustable resistors, public address systems, amplifiers and valuable data on volume-control circuits, are contained in this 10-page booklet.

6. *Lime-Voltage Control*. A series of folders giving complete descriptions of the characteristics of the Amperite line-voltage con-

radio circuits as one of the most important factors in determining the location of troubles in radio receivers. The information, procedure and equipment required to make such tests, efficiently, are given.

Review of Articles in the August, 1932, Issue of the Bell Laboratories Record

Noise-Reducing Aerials, by Floyd Fausett. A discussion of the various simple means which can be adopted for minimizing the effect of man-made interference on radio reception.

Photoelectric Relays and Their Applications, by A. J. McMaster. This paper points out the fields existing for photoelectric relays and explains how radio servicemen can capitalize on their ability to design, install and maintain equipment using these units.

A Permanent-Magnet Light Valve, by G. E. Perreault. A complete description of a light valve for use in sound-on-film recording which employs a compact, light-weight permanent magnet instead of the heavy and cumbersome electromagnet usually used in such units, is described in this paper. The new unit is more efficient than the electromagnetic type and requires less accuracy in its adjustment, a factor that makes it particularly well suited for portable use.

Portable Sound-Picture System for 16-Millimeter Film. A projector which incorporates a turntable, driven in synchronism with the film so as to provide the many advantages of sound accompaniment in a portable outfit, is described in this article. The complete outfit is contained in two compact carrying cases, one of which carries the complete projector-turntable unit

Free Technical Booklet Service

Through the courtesy of a group of radio manufacturers, RADIO NEWS now offers its readers this new Technical Booklet Service. By means of this service readers of RADIO NEWS will be able to obtain quickly and absolutely free of charge many interesting, instructive and valuable booklets and other literature which formerly required considerable time, effort and postage to collect.

To obtain any of the booklets listed in the following section, simply write the numbers of the books you desire on the coupon appearing at the end of this department. Be sure to print your name and address plainly and mail coupon to the Radio News Technical Booklet Service. Stocks of these booklets and catalogs are kept on hand and will be sent you promptly as long as the supply lasts. Do not send for any material in which you are not actually interested in order to avoid waste of needless postage

7. *1932 Resistor Catalog*. Complete specifications on the International Resistance Co. line of metallized, wire-wound and precision wire-wound resistors, motor-radio suppressors, handy servicemen's kits, valuable technical data and list of free bulletins available are contained in this 16-page catalog and handbook.

8. *1932 Receiver and Transmitter Condenser Catalog*. This 4-page folder gives complete specifications and list prices on the

and the other the loudspeaker and amplifier unit.

Review of Contemporary Periodical Literature

Graphical Determination of Polar Pattern of Directional Antenna Systems, by G. L. Davies and W. H. Orton. Bureau of Standards, Research Paper No. 435. The methods for determining the polar patterns of directional antenna systems described in this paper are less tedious and more generally applicable than computation from available mathematical equations.

Bridge Methods for Measurements at Radio Frequencies, by Charles T. Burke. General Radio Experimenter, July, 1932. The precautions which must be observed in using bridge methods at radio frequencies are discussed in this interesting and helpful treatise, which outlines the essential differences between bridge measurements at low and high frequencies.

A Solution of the Superheterodyne Tracking Problem, by V. D. Landon and E. A. Sveen. Electronics, August, 1932. A method of mathematically determining the value of inductance and capacity required in the oscillator circuit for reasonably perfect tracking in superheterodyne receivers is given in this article. This method is far simpler and much more satisfactory than the tedious cut-and-try experimental method usually employed in such design problems.

An Improved "B" Eliminator for Automobile Receivers, by W. W. Garstang. Electronics, August, 1932. This article points out the weaknesses of conventional automobile power-supply circuits and explains an "automatic load delay" circuit which prevents damage to the power-supply equipment while the receiver and rectifier tubes are reaching their operating temperatures, and eliminates "no load" operating conditions.

Dynamic Speaker Design—Part II, by A. R. Barfield. Electronics, August, 1932. A continuation of the article in the June issue dealing with the mathematic determination of the factors which make for maximum efficiency at minimum cost.

Electronic Speed and Acceleration Recorder, by H. M. Partridge, Ph.D. Electronics, August, 1932. A description of a circuit for timing and recording rapidly successive phenomena such as velocities and accelerations of electric motors under varying operating conditions, velocity, acceleration and deceleration of automobiles, airplanes, foot and horse racers, etc.

9. *1932 Resistor Catalog*. Complete specifications on the International Resistance Co. line of metallized, wire-wound and precision wire-wound resistors, motor-radio suppressors, handy servicemen's kits, valuable technical data and list of free bulletins available are contained in this 16-page catalog and handbook.

10. *Information on the Suppression of Motor-Radio Noises*. This interesting and useful folder of the International Resistance Co. gives complete information on how to overcome motor-generator, ignition-coil, in-terrupter and spark-plug noises in automobile installations.

11. *1932 Receiver and Transmitter Condenser Catalog*. This 4-page folder gives complete specifications and list prices on the

Flechthem line of both high and low-voltage fixed paper condensers for bypass and filter use in transmitting and receiving equipment.

12. *Certified Tube Plan for Servicemen and Dealers.* A special plan of the Triad Mfg. Co., which makes it possible for servicemen and dealers who maintain a service department to obtain certified Triad tubes direct from the factory at discounts that enable them to make tube replacements at attractive profits, is described in this folder.

13. *The Compensating Phonovox.* Description of Pacent phonograph record-reproducing unit, designed to meet every requirement of high-quality reproduction from records for home, broadcast station and talking movie installations.

14. *Popular-Priced Phonovox Reproducers.* A folder containing complete descriptions of the Pacent No. 120 and No. 160 electric phonograph reproducers for home use.

15. *Phonograph Recorder and Reproducer.* Detailed description, specifications, installation and operating notes on the versatile Pacent No. 171 recordovox for both making and reproducing records electrically through the amplifiers of standard receivers.

16. *RMA Standard Resistor Color-Code Chart.* A handy post-card size color-code chart, designed by the Lynch Mfg. Co. to simplify the job of identifying the resistance values of resistors used in most of the standard receivers. It also contains a complete list of the most commonly used values of resistors with their corresponding color designations.

17. *1932 Radio Instrument Catalog.* This 20-page book on Weston and Jewell radio measuring, testing and servicing instruments is without doubt the most complete of its kind. A copy should be in the hands of every engineer, serviceman, purchasing agent, teacher or anyone in the industry who uses or specifies measuring and testing instruments.

18. *A Baptism of Fire.* This interesting 16-page booklet describes, in non-technical language, the materials and processes used in making Centralab fixed resistors. Specifications and list prices are included.

19. *Making Auto-Radio and Farm Sets All-Electric.* This circular gives complete specifications and description of the features of the Carter genemotor which is designed

to eliminate "B" batteries in connection with automobile, aviation, farm and other similar sets. A dynamotor unit, operating from the storage battery and consuming less current than a parking light, is employed.

20. *Multiplying the Value of Meter Dollars.* This useful folder shows how to use Shallcross resistors to make multi-range voltmeters and ohmmeters and bridges. A chart indicates the proper value of resistance required to convert milliammeters of various ranges into voltmeters of any desired range. Specifications and list prices of standard Shallcross super Akra-ohm resistors are included.

21. *Exact Duplicate Replacement Transformers.* This folder gives complete information, with receiver name and model numbers, on a complete line of replacement transformers, chokes, audio transformers and output transformers made by the Standard Transformer Corp. The units listed are exact duplicates, electrically and mechanically, of the originally installed transformers used in many popular sets now in use. It is a handy guide for the serviceman in replacing defective units.

22. *Standard Resistor Stock List.* A 6-page folder giving complete specifications and list prices of the complete line of Ohmite fixed, semi-variable, meter-multiplier, transmitting, voltage divider and power-pack resistors, non-inductive resistors, slide-wire, rheostat-potentiometers and power rheostats.

23. *Replacement Resistor Bulletin.* This folder gives a complete list of Ohmite "Red-devil" replacement resistor units designed to withstand high temperatures and also gives complete listings and data on a new type of vitreous-enamel, semi-variable resistors that are ideally suited for use as replacement voltage dividers.

24. *Free Servicemen's Kit Offer.* This folder explains how it is possible for any serviceman or dealer to obtain, without actual charge, a Sylvania service kit, 17 inches long, 7 inches wide and 10 inches deep, built of 3-ply veneer, covered with black leatherette and provided with decorative brass fittings, lock, key, kit for small parts, tool tray, literature rack and space for 20 assorted tubes.

25. *Noise-Reducing Antenna System.* A detailed description, with technical data, on a new antenna system perfected by the Lynch Mfg. Co. which is effective in eliminating the great majority of electrical noise interference on both broadcast and short-wave reception. It is especially suited for application on all-wave receivers which have heretofore given unsatisfactory results because of objectionable interference on the shorter waves. It can be applied to existing installations and offers a big field for profitable jobs for the serviceman. Its use on amateur receivers makes possible more and better QSO's.

26. *The Basic Training a Serviceman Needs.* This is an outline of a course to prepare the beginner or established serviceman to meet the rigorous demands of modern radio servicing. The outline covers the fundamental subjects of radio and the special subjects of service technique and procedure in understanding circuits, equipment and the location and elimination of radio troubles.

27. *Wire Products and Antenna Supplies.* A 4-page folder giving complete specifications of a wide variety of bare and variously insulated, solid and stranded wires for aerials, coils and transformers. Descriptions of aerial supplies, antenna kits, insulators, lead-in strips, lightning arrestors and ground clamps are also included.

Porcelain German Radio

(Continued from page 273)

the power tubes as specially-designed earthenware pots, formed by helics of earthenware tubes are provided instead.

All seven stages of the Leipzig transmitting equipment will be provided with screened-anode circuits. For the output stage (in addition) filter circuits will be used. In Figure 1 the location of the filter units in the

closed on all four sides by glass-backed lattice-doors. Two of these doors, which may easily be pulled out of their respective spring-locks in the frames of the units, are to be seen through units one and two in the background of Figure 2.

For controlling and supervision the operation of the transmitter, a control and monitoring desk will be provided. This desk will be located in the center of the semicircle formed by the various units of the transmitting equipment in the transmitter room as shown in Figure 1. It will contain all necessary instruments, keys, etc., for starting, operating and shutting down the transmitter.

A mercury-arc rectifier will be used for

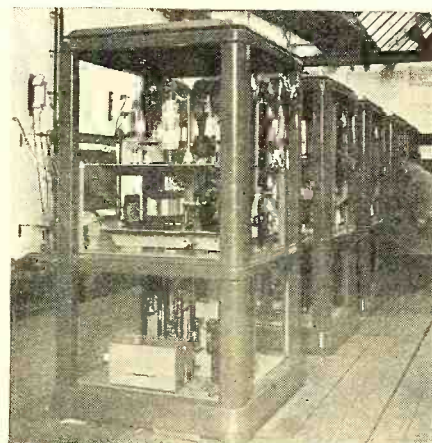

FIGURE 3

transmitter room is indicated. On the right side of Figure 8 two of these units are shown. The filter circuits are formed of copper-tube, inductance coils. The unit on the left side of Figure 8 houses the antenna-tuning circuit. These units, as well as those shown in Figures 2, 3 and 4, will be en-

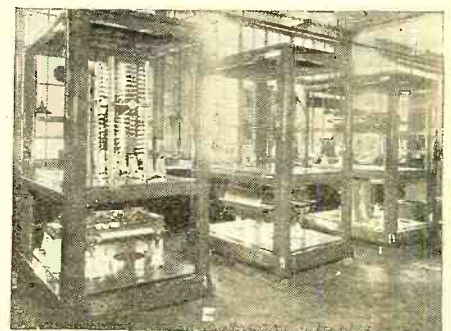

FIGURE 8

supplying the required energy for the anodes of the power amplifier tubes, a 2000-volt motor-generator generating the anode cur-

November, 1932
RADIO NEWS Free Technical Booklet Service
 222 West 39th Street
 New York, N. Y.

Gentlemen: Please send me, without charge, the booklets or folders I have filled in below:

Numbers.....

Radio Engineer
 Serviceman
 Experimenter
 Laboratory Technician
 Dealer
 Jobber
 Manufacturer's Executive
 Professional or Amateur Set Builder
 Licensed Amateur
 Station Operator

I am a subscriber newsstand reader.

Name.....
 Address.....
 City..... State.....

rent for the tubes in the initial stages of the transmitter. Grid bias for all tubes of the equipment will be supplied by a common 500-volt machine. A 45-volt and an 80-volt motor-generator will supply the filament currents for the initial stages and the power stages, respectively.

The new 75-kw. transmitter for Munich is being constructed on the same system, using similar units for the transmitting equipment. According to its lower rating, it will have but two 140-kw. water-cooled transmitting tubes in its output-power units, requiring one porcelain stand, only, for each of the units. This station will probably be opened in October. The 25-kw. equipment for Frankfort will be a common-wave transmitter, working on the same wave as Leipzig. Its opening will also take place in the Fall of this year.

Radio Aids Voters

(Continued from page 269)

below:

1. Choose a network of stations for any particular speech that will reach the type of voters the speech is directed to. There have been many campaign speeches dealing with special subjects that are not interesting to all the voters.

2. When the radio speech is to be directed to all the voters in the country, be sure that it deals with the general situation, concentrating on the political features outstanding in the minds of everyone.

3. Remember that a large part of your audience is women who have not been as familiar with political parlance as men.

4. Speak clearly and slowly, so that not a word or phrase of your speech will be misunderstood.

5. Outline very clearly just what you would do with the issues at hand and how you would set into motion the necessary machinery to carry it out.

6. Do not try flowery oratory or shouting or emotional passages. They do not sound well on the receiving end of Radio and good logic and clarity would go much farther. Speak plain English!

7. Do not try to evade an issue in a radio speech. Evasion will be quickly felt in the listener's home and you will be criticized severely by potential voters.

8. Be sure that every statement you make is a fact or a principle that can be illustrated.

9. Tell the truth and don't throw "mud."

10. Do not forget that you are talking "face to face" with your fellow man who is to vote either for you or against you.

At any rate, let us all, voters, campaigners, candidates, make the next November 8th, Election Day, one that will do credit to human intelligence and to Radio itself. The way to the White House runs through the Radio path this year.

P. R. Mallory & Co., Inc., Grants Another Dry Electrolytic Condenser License

INDIANAPOLIS, IND.—P. R. Mallory & Co., Inc., who pioneered and developed the field of dry electrolytic condensers under the Mallory-Elkon brand, has granted a license to Magnavox Co., Ltd., through their subsidiary, Electro-Formation, Inc.

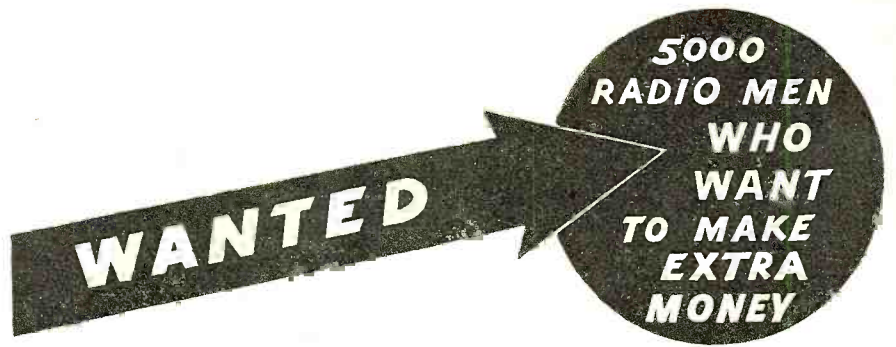

Since radio receivers have become so popularly equipped with resistors, a new service has been created—for resistors, like other parts, cannot go on forever. "Look to your resistors" has become an important by-word when sets are not performing satisfactorily. This is but one of the opportunities OHIOHMS offer the service man.

OHIOHM FIRST-AID RESISTOR KIT

Pocket size. Furnished in 1-watt and 2-watt kits. OHIOHM resistors are protecto-packed to keep wire leads straight. . . Each unit stamped with resistance value.

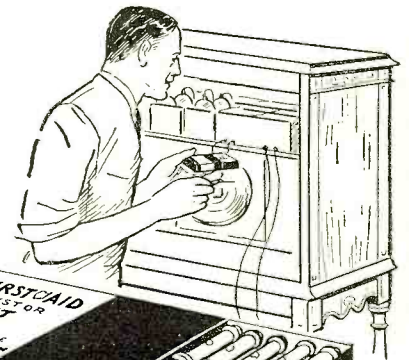

FREE



With initial order of First-Aid Kit a supply of service labels for your imprint, an OHM DIAL for instantly telling resistance values of resistors to be replaced, and a handy Guide are given free.

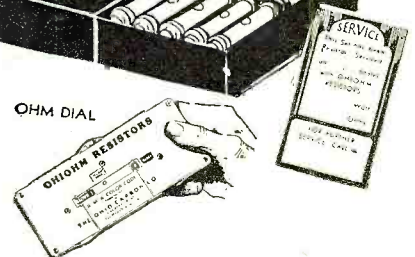

OHIOHM SPARK SUPPRESSOR SETS for eliminating ignition interference on automobile radios

Here is another virgin field in which to make extra money . . . Automobile radios—ever on the increase—require spark suppressors to silence ignition noises. . . OHIOHM Suppressor Sets are made for 4, 6 and 8 cylinder cars, complete with condenser and necessary suppressors.

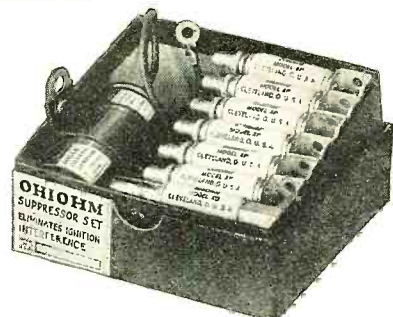
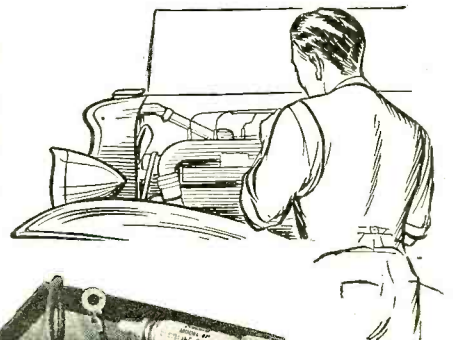

Write us for General Folder, stating Distributor or Dealer from whom you usually buy.

OHIOHMS are made in Canada by C. C. Meredith & Co., Limited, 67 Bay Street, Toronto

THE OHIO CARBON CO. • 12508 Berea Road • Cleveland, O.



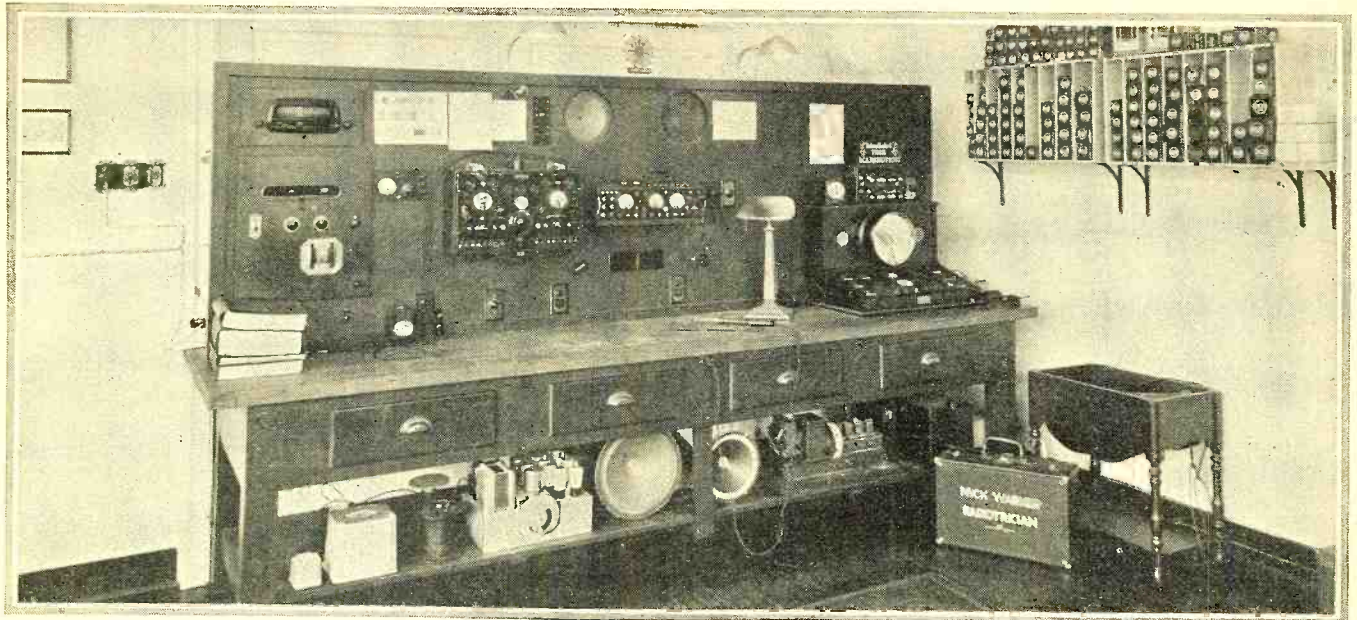

The Service Bench

Service Sale Promotion—Sales Letters—The Business Card—Service Letterheads—Service Shops—A Service Resistometer—New P-A Equipment—Servicing Philco

THE desirability of consistent sales promotion as an adjunct to radio service is being conceded definite recognition by successful service organizations. The various ideas suggested by RADIO NEWS have been presented for the benefit of our service readers. Their use has entailed no obligation of any kind, and it has been decidedly gratifying to receive evidence of their incorporation in practical service sales promotion.

The proprietor of a radio service shop in a central New York State city (population 40,000) writes: "We came across a suggestion in the June *Service Bench* that was of particular interest to us. This was the advisability of featuring an unusual line-up of programs on the air this summer. Enclosed you will find a sample of direct-mail advertising used by us recently, which produced very satisfactory results and is still bringing in considerable business."

A Service Sales Letter

The letter, which is printed (it might be cheaper and equally effective if multigraphed or mimeographed) on the business letterhead of the service shop, follows:

"Dear Friend: Your radio will bring to your home during this summer programs unique in broadcasting history. To mention only a few:

"**POLITICAL:** The most important political battle of this generation is on. Prominent statesmen and business experts will discuss vital issues over the air; opposing candidates will debate payment of the bonus—federal aid to banks, railroads, and agriculture—government ownership of power resources—prohibition, etc.

"You will follow the National Conventions in Chicago more accurately than actual spectators; complete election returns will be known as rapidly as tabulated.

"**SPORTS:** This is a banner year for sporting events: broadcasts of International

*Conducted by
Zeh Bouck*

League ball games—vivid descriptions of horse-racing classics (usually on Saturday)—important boxing and wrestling matches—intercollegiate meets. When the pick of the world's athletes compete in the Olympics,

of current conditions, increasing importance. "ENTERTAINMENT: Restricted budgets curtail funds usually devoted to outside amusement, placing greater demands on radio to entertain the whole family.

"You will find your radio indispensable during the next few months. It is essential to your complete enjoyment that it be working at peak efficiency.

"Our complete equipment, broad experience with all makes, and comprehensive stock of repair parts, make possible efficient service at the lowest charges consistent with satisfactory work.

"A phone call will place our facilities at your convenience.

"Thank you,
"RADIO SERVICE SHOP,

"Per.....
"Prop."

By taking minor liberties with the above letter, it is readily revamped for the winter season. "Political" might be modified to consider David Lawrence's Sunday night discussions from Washington, and the inevitable campaign speeches—and the inauguration itself. The National Conventions, of course, are out; and hockey, football and basketball sub for contests on the diamond. The remainder of the letter can be copied almost verbatim.

A P. A. Sales Letter

A correspondent from Richmond, Va., writes that he is adding public-address rental equipment to his general line of radio merchandise, and requests a sales letter to prospective clients. Such a letter should consider the specific requirements of the individual client, the nature of the contact and to that extent cannot be a form letter. However, the introduction and conclusion can be more general. The salutation will, of course, vary with the intimacy with which the recipient is known to the sender, running the entire gamut from "My Dear Joe" to "Gentlemen." A suggestion for the opening

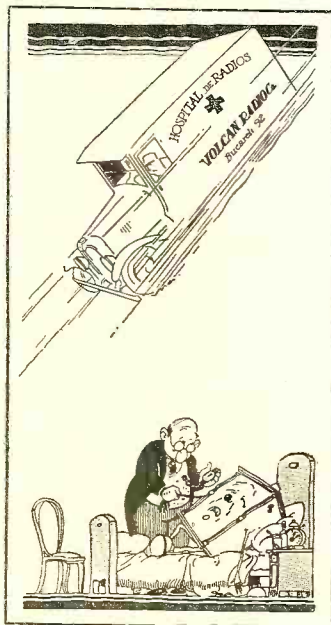

FIGURE 1

you will occupy a front seat at every event. And you will witness the entire World Series from Graham McNamee's press box.

"**NEWS:** News flashes, résumés of business and political developments, attain, in view

paragraph of the letter follows:

"In recognition of our rising civic importance and the necessity for a more satisfactory coverage of community events, our organization is prepared to supply the highest quality public-address equipment for sound broadcasting. Our microphones, amplifiers and speakers are of the most modern types and are designed to provide satisfactory coverage of audiences, numbering as high as 5000 persons, with the ordinary speaking voice.

"The equipment can be readily installed either indoors or out, and while primarily designed for the broadcasting of voice, is

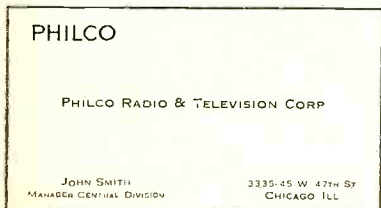

FIGURE 2

readily adaptable to musical pick-up, phonograph or radio broadcasting, and talking motion pictures."

The next paragraph should logically point out the applications to the anticipated needs of the particular client being addressed—school auditorium, community picnics, political get-togethers, town board meetings, etc. The concluding paragraph may revert to generalities:

"The apparatus is installed and operated by competent engineers, and our reputation for expert service guarantees every installation. Our prices are the lowest consistent with reliable and thoroughly satisfactory public-address work. We should be pleased to quote you on rentals and permanent installations and arrange for a demonstration at your convenience."

A Tip from Our May Issue

It is possible that the Vulcan Radio Company, of Mexico City, found their inspiration for an excellent sales circular in the suggested ambulance advertisement shown in this department for May. At any rate, it is a good idea (so we thought all along), and the adaptation is illustrated in Figure 1. A second cartoon appears inside the folder, depicting a blindfolded man—*hombre vendado*—ripping the entrails out of a perfectly good radio set. The caption, translated, reads:

"Would you trust your body to the hands of a blind surgeon? Then why trust your radio to the hands of a man with his eyes

The Business Card

Figure 2 shows a handsome business card, arrangements for the distribution of which, at cost, have been made by the Philco company. These cards are available to Philco dealers, salesmen and authorized service stations. The word "PHILCO" is die-stamped in red, while the remainder of the card is processed in a high grade of plateless engraving. The card stock is blue water engravers' Bristol—the finest obtainable. The prices in lots of 250 is \$2.60. Blank cards, with only the die-stamped trade-mark, are \$3.50 a thousand. (Mention RADIO NEWS when you write.)

The two attractive letterheads shown in Figure 3 add the final artistic and practical touch to our sale tips for the month.

THIS MONTH'S SERVICE SHOP

The palm, this month, goes to N. H. Walker, proprietor of the Supreme Radio Service, Egg Harbor City, N. J. His service shop—among the neatest brought to our attention—is shown at the head of this department. The test and analysis equipment consists of types AAA-1 and 400-B diagnetometers, preheater and short tester (all by Supreme), a Jewell portable ohmmeter and broadcast and intermediate-frequency oscillators. The diagnetometers are removable for portable service. A desirable innovation features an impedance-matching panel for matching all types of dynamic speakers, on test, with the output of a standard receiver. Provision is made on the panel for the coupling of amplifier and speaker combinations to the output of a phonograph pick-up, facilitating quality tests and general check-up on a.f. systems. Special apparatus checks electrolytic condensers and low-ohmage resistors. Direct-current voltages from 2 to 250 are available for testing battery receivers.

All apparatus receiving power from the a.c. mains is controlled by individual switches and monitored by pilot lamps. The more common and useful formulas are framed on the panel, along with tube characteristics, oscillator and spectra charts. The drawers in the bench contain stocks of condensers, resistors, transformers and other small replacement parts. On the left-hand end of the bench are the more important of the authentic service manuals.

A Radio Service Resistometer

By M. H. Berry
(Columbia, Tennessee)

"The resistors in many radio receivers, particularly those of less modern vintage, are

SERVICE CALL	\$2.00	<p>YOUR PHONE CALL ME IN A MINUTE PHONE 74-658</p>	<p>OUR MODERN RADIO TEST EQUIPMENT RESULTS IN SPECIALLY ACCURATE SERVICE THAT COSTS NO MORE THAN ORDINARY GUESS WORK.</p>
SHOP WORK, MIN.	3.50		
LARGE, PER HOUR	1.75		
HOOR-UP	2.50		
COMPLETE INSTALLATION	8.00	<p>SILVERMAN RADIO SERVICE</p> <p>2907 VINE AVENUE LORAIN, OHIO</p>	

SUPERIOR SERVICE	<p>JEWELL</p>	JAX. 3220
NATIONAL RADIO SERVICE MEN'S ASSO.		<p>Southern Radio Service Company</p> <p>RADIO ENGINEERS Mobile, Alabama</p>
		P. O. BOX 1384

FIGURE 3

bandaged? WHAT ONE DOES NOT KNOW IS THE SAME AS WHAT ONE CANNOT SEE!"

The point is obvious—the advertising good.

not identified by the R.M.A. color code. When such resistors are burnt out, the determination of the correct value for replacement.

(Continued on page 319)

Cash in with NEWEST, MOST RELIABLE METHOD of SET ANALYSIS

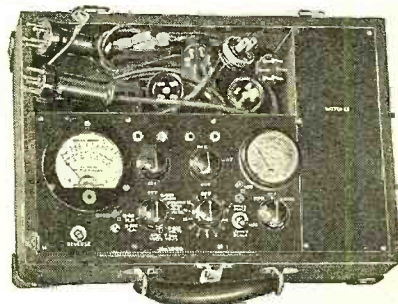

Readrite

No. 1000 Tester

Tests—Voltages, Milliamperes, Point-to-point Resistances, Continuities, Short Circuits, Capacities.

\$33 Net to Dealer

TWO cable plugs connect set sockets through selector switch to the precision volt-milliamper-ohmmeter... an exclusive Readrite feature. Speeds up tests without removing chassis. Measures resistances up to three megohms—D.C. Volts up to 600 and milliamperes up to 300. Also A.C. line volts and capacity of dry and electrolytic condensers.

A fine instrument in leatherette case. Complete with batteries, test cords and full instructions.

READRITE METER WORKS
20 College Ave. Bluffton, Ohio

MAIL TODAY

Readrite Meter Works,
20 College Ave., Bluffton, Ohio

Gentlemen:
Please send me information about Readrite No. 1000 Resistance Continuity and Capacity Tester. Also Catalog of other servicing instruments.

Name.....

Street Address.....

City.....State.....

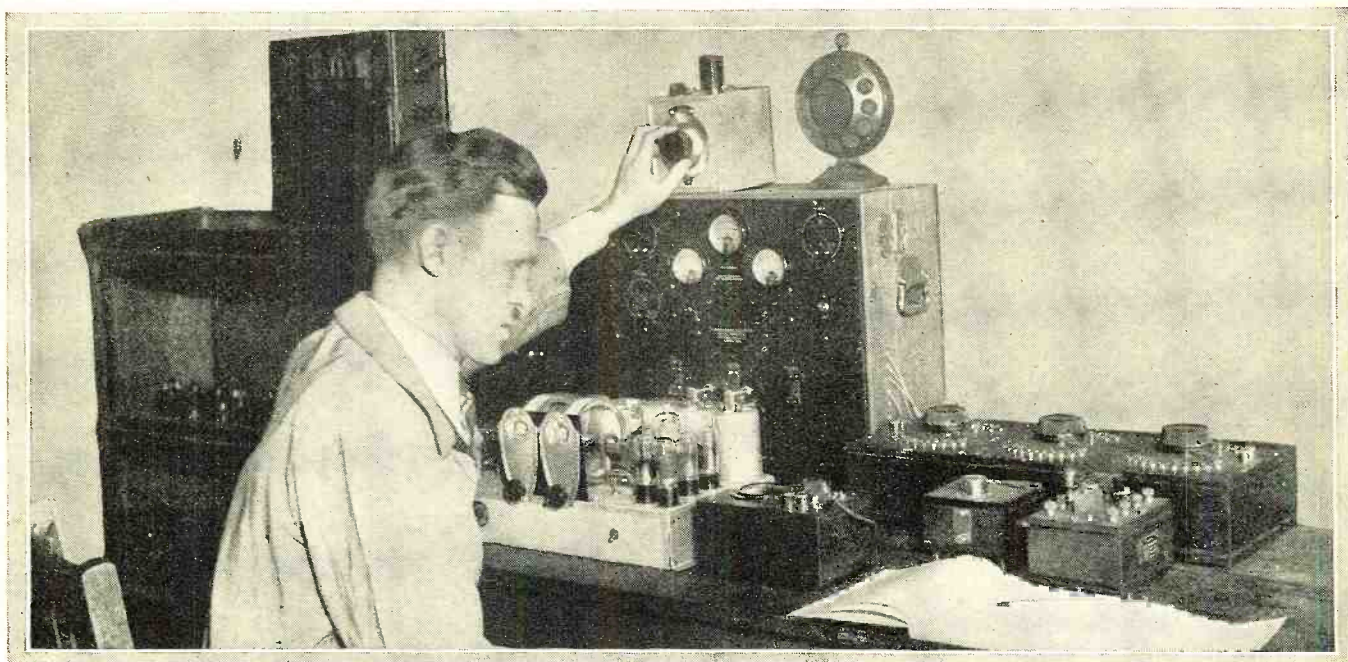

With the Experimenters

Testing New Tubes, Home-made Microphone, Soldering Tips, Improving the "Ground," Improving Plug-in Coils, A Photo-Cell Use, Matching Low Impedance Pick-ups

Testing the New Tubes with "The 'Complete' Service Unit"

Numerous requests have been received from readers asking for information concerning the testing of the new tubes in the analyzer and a.c. tube checker of "The 'Complete' Service Unit" described in the March and April issues. The following provides a description of the equipment and procedure necessary to test the new six-prong pentodes, automobile tubes and others.

Heretofore practically all of the pentodes have had their suppressor grid internally connected either to the cathode or the mid-point of the filament. If the proper care has been exercised in the design of an analyzer, no adapters would be required for testing this type of pentode. An example of such an analyzer is "The 'Complete' Service Unit," which incorporates a voltage return switch to shift all d.c. voltage readings with respect of filament or cathode.

In designing the "Complete' Service Unit," the author had the foresight to provide facilities for testing pentodes having an external suppressor grid connection. An extra wire in the analyzer cable carries the suppressor grid from a tip-jack on the main panel to the metal lock-on latch in the Na-ald analyzer plug. This provision makes the testing of the new pentodes less complicated, due to the fact that no external

Conducted by
S. Gordon Taylor

inter-connections are necessary between the radio being tested and the analyzer, excepting those provided by the analyzer cable.

The Alden Manufacturing Company has recently brought out a new line of sockets and adapters suitable for use in testing the new six-prong pentodes. At right is shown the internal connections of Na-ald adapter No. 956 DS, which has a five-hole top and a six-prong bottom. As you will note, the suppressor grid is carried from the suppressor grid prong to the lock-on stud. At left are shown the internal connections of Na-ald adapter No. 965 SL, which has a six-hole top and a five-prong bottom. A six-inch phone-tipped lead carries the suppressor grid to the proper wire in the analyzer cable.

Analyzing Circuits

To analyze the circuits of a -57 or -58 six-prong pentode, lock the 956 DS adapter on to the Na-ald analyzer plug. Remove the tube from its socket and plug the above assembly in its place, not forgetting to clip the control grid lead to the cap on the analyzer plug. Insert adapter No. 965 SL in the UY analyzer socket of the "Unit" and plug the phone-tipped lead into the "Sup. G." tip-jack on the main panel. Place the tube, previously removed from the radio set socket, in the six-hole top of this adapter and complete the control-grid circuit of this tube by means of the lead marked "E," page 856, April RADIO NEWS. Put the voltage return switch (S4) in the "K" position and proceed to test the various circuits in the usual way. Measure the suppressor grid

voltage with S1 in the "Spr. G. V." position and one of the voltage buttons, S15 to S19 inclusive, pressed. If the suppressor grid is tied directly to the cathode, there will be no indication on the meter, M1. In the latter case, placing S1 in the "K. V." position will enable us to read the suppressor grid and cathode voltage with respect to the heater. It may be necessary, in some cases, to reverse the meter reading by pressing the "Rev." button (S8).

A slight improvement in this pentode testing may be realized if the wire connected to the negative point of switch S1 is removed from the K circuit of the analyzer and soldered to the pole of the voltage return switch (S4). This will permit suppressor grid readings to be taken from heater or cathode, merely by changing the position of the switch.

The -56 type tube is tested the same way as the standard -27.

A later article in this department will contain information on testing the above-mentioned tubes in the a.c. tube checker of "The 'Complete' Service Unit."

W. GERBER,
New York City.

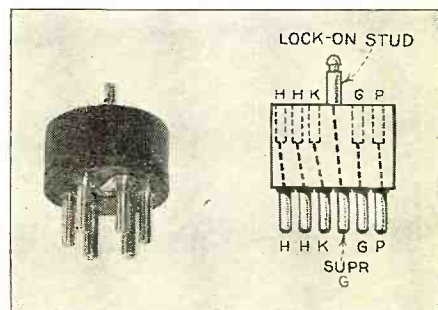
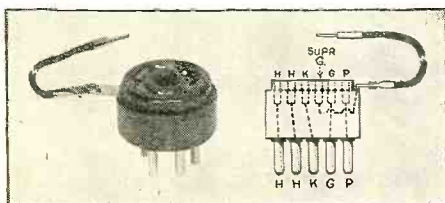

Home-made Experimental Microphone

IT is not always realized to what extent things about us are affected by the sound waves of one's voice when we speak. Recently I attached a carbon-disc-and-button arrangement to a window-pane and, using an amplifier and headphone, picked up children's voices from as far as a block away. The button I speak of is not to be confused with a microphone button. The apparatus consists of a small disc of carbon, which can be cut with a saw from the carbon rod of a flashlight cell. Upon this lightly rests the button, which is a rounded, smooth hemisphere of carbon. This can also be cut from

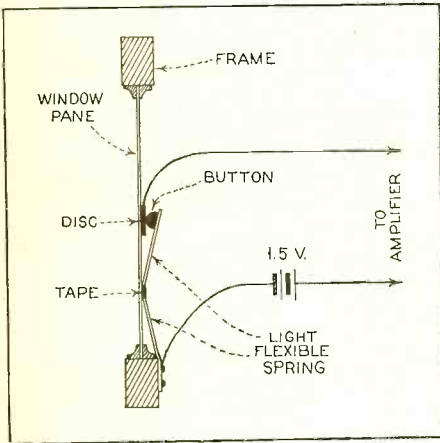

the carbon rod (it should be cut about 1/2 inch long, while the disc should be only about 1/4 inch) and one end rounded with a file and fine sandpaper. Glue the disc to the window-pane, having first twisted a thin flexible wire about it to serve as one terminal lead. The button should be glued or otherwise attached to a long flexible metal band, such as is found inside a ten-cent-store spring tape-measure, and electrically connected to it. The other end of this spring is thumb-tacked or screwed to the window frame in such a position that the button is opposite the disc and contacts it lightly. The middle of the spring should be taped with adhesive tape to the pane to prevent the spring from curling up. This disc-and-button arrangement is similar to one of the early Wheatsthorn types of microphones, and though it is crude of adjustment, will, if the electrodes contact lightly enough, pick up even extremely feeble sounds.

Ingenuity allows such a unit to be placed on such things as boxes, bowls, cans, lamp-shades, window-shades, furniture, etc., to demonstrate their various reactions to sound waves. Incidentally, be careful that a loud sound or shock does not cause the electrodes to break contact while you are listening, or your ears will suffer.

EDWARD O. LINDEMANN,
Stapleton, New York.

Soldering Tips

Connections between wires and conductors in radio and electrical work should be protected with solder if highest efficiency is desired. To insure a sound and permanent electrical connection between two wires, they should first be cleaned thoroughly, then joined so that a connection that is electrically conductive and mechanically secure is formed, and then the connection should be covered with solder to keep it in that condition. The coating of solder not only prevents vibration and the constant expansion and contraction of the metal caused by temperature changes from loosening the connections; but it also prevents the formation of metallic oxides that would introduce a high resistance at the connection. The solder

forms a coating that is flexible and lasting, and one that will not lose its conductivity with age.

CHARLES FELSTEAD,
Los Angeles, Calif.

Improving the "Ground"

I found that by dosing it with ordinary salt the "ground" for my radio was made considerably more effective.

I made two gallons of a solution, consisting of one part salt to three parts water, and poured this on the ground around the pipe which is driven into the earth to provide my "ground". The salt in the solution is thus distributed through the earth surrounding the pipe. Its well-known affinity for water results in the earth being kept moist, thus providing a better conducting medium around the pipe.

JAMES C. COLLEY,
Powderly, Ala.

Suggestion for Plug-in Coils

When experimenting with hookups using plug-in coils I find it advantageous to attach a small trimmer condenser to the coil itself and remove the trimmer on the tuning condenser. This idea may also be used on catcombs where the entire coil is thrown in and out of the circuit by means of tap switches.

The advantage of the above method is obvious. Each individual coil will differ slightly from the others, even though they are matched, and the same thing is true of the sections of the tuning condenser. Consequently each coil must be adjusted to its respective tuning condenser. The coils will of course have to be marked so that they will always have the same position in the circuit.

M. S. SOLBERG,
Berwyn, Ill.

Practical Work for the Photo-Cell

A recent application of their Photronic relay suggested by the Weston Electrical Instrument Co. employs a pre-determined meter reading to actuate the relay and in this way, to perform other useful functions. Any indicating device, such as a speedometer, a pyrometer, a clock, an ammeter, a voltmeter, etc., may be used in this application, provided that the indication is given by means of a swinging or rotating arm or needle.

A mirror is fastened on the needle in such a way that when the needle swings to any pre-determined position or reading, a beam of light will be reflected from a spotlight, directly upon a Photronic cell. The light

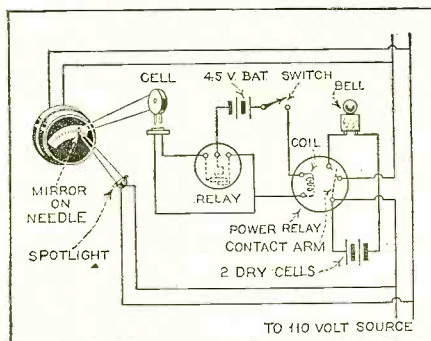

may be arranged within a small tube, in order to concentrate it more readily upon a limited area. When the light is reflected upon the light-sensitive cell, it energizes the cell thus closing the relay circuit.

In the accompanying diagram, a circuit is shown, whereby a certain meter reading will cause the Photronic cell to operate the miniature relay and this in turn will actuate the

(Continued on page 318)



NATIONAL UNION
meets the service man
MORE THAN HALF WAY!

No other tube manufacturer offers more to help service men and dealers

Radio men everywhere are telling us what National Union means to them. And the reason why is that National Union understands and does something about the service man's problems—

1. National Union sells High Quality Tubes.
2. National Union offers FREE the finest equipment.
3. National Union gives the latest data on radio equipment.
4. National Union assures a profit . . . there is no price cutting.

Look at the valuable free equipment in this ad. Decide today to tie up with National Union for profit. Mail coupon below!

ASK YOUR JOBBER'S SALESMEN



Unameter Tester is easy to operate. Compact, sturdy meter. An aluminum chassis, with all panels made of bakelite. Don't miss this opportunity. Free with moderate purchase of tubes and a small deposit.



Latest method of servicing! New Readrite continuity, capacity and resistance tester! With this tester you can make every test . . . without taking the set apart! Free with small purchase of tubes.

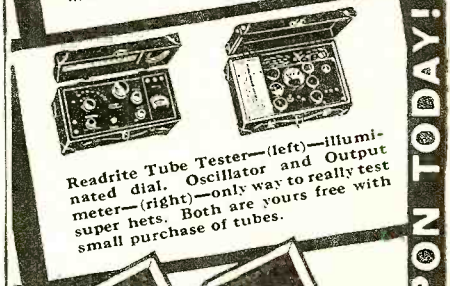

Two service manuals by John F. Rider—Vol. I. Over 2000 diagrams on voltages, color codings, etc. Vol. II. Over 700 pages. Resistance data making possible operation of tester above.

NATIONAL UNION RADIO CORP.
400 MADISON AVENUE, NEW YORK

SR-11
Sirs: I am interested in following equipment:
Readrite Tube Tester Oscillator & Output Meter
Readrite Resistance Tester Volume I Volume II Unameter

NAME _____
ADDRESS _____
CITY _____ STATE _____

MAIL COUPON TODAY!

Question Box

PHYSICS and science instructors will find these review questions and the "quiz" questions below useful as reading assignments for their classes. For other readers the questions provide an interesting pastime and permit a check on the reader's grasp of the material presented in the various articles in this issue.

The "Review Questions" cover material in this month's installment of the Radio Physics Course. The "General Quiz" questions are based on other articles in this issue as follows: 5-Meter Measurements; A Pocket Diagonometer; Rejecto-static Reception; Television and Sound on One Wave; With the Experimenters.

Review Questions

1. Explain three ways in which e.m.f. may be produced. Which is used most in practice?
2. What is the internal resistance of a 6-volt storage battery which delivers 300 amperes on short-circuit through a cable of negligible resistance?
3. How does an ion differ from an electron? What is a positive ion?
4. What is a depolarizer?
5. Describe the internal construction of a dry cell and state why a dry cell must be discarded when it is used up.
6. Why is a dry cell not adapted to service where it must supply a current steadily for some length of time?
7. What causes "local action" in a battery cell?
8. What are two methods used to prevent this "local action"?

General Quiz on This Issue

1. Why is the Lecher wire system generally impractical for use as a wavemeter in conjunction with ultra-short-wave amateur equipment?
2. What measurement equipment is to be preferred? How is it calibrated?
3. In a set tester which provides a variety of current ranges is it preferable to obtain these by using low resistance shunts directly across the meter, or by measuring the voltage drop across a resistance of known value? Why?
4. What is meant by "point to point" measurements when this term is applied to a set analyzer?
5. How does the system for eliminating "man-made" static interference, as described in this issue, function?
6. How is the detrimental effect of the relatively high capacity of the shielded lead-in eliminated in this system?
7. Explain the system recently adopted in transmitting sight and sound on the same carrier frequency.
8. Describe the construction of a simple home-made "mike."

Student's Radio

LESSON TWELVE—BATTERIES

By Alfred A.

This series deals with the study of the physical information of particular value to physics colleges. The Question Box aids teachers

A SIMPLE primary cell may be made of a plate of zinc and one of carbon dipping into a jar of ammonium chloride (NH_4Cl —sal ammoniac solution). A conducting circuit connects the two plates outside of the solution as shown in Figure 1. In the electrolyte (ammonium chloride) there are present the ions NH_4 (ammonia) and Cl (chlorine). When zinc is immersed in the solution, Zn ions enter the solution. The Zn ions are positive because each has left behind on the zinc plate two electrons. This accumulation of negative electrons constitutes a negative charge on the zinc plate. The Zn ions, on entering the solution, repel the H ions and the NH_4 ions that are already present. In this simple cell, the H and the NH_4 ions are repelled toward the carbon plate. The H and the NH_4 ions reaching the carbon plate take electrons from its atoms and form neutral hydrogen and ammonia atoms which collect on the surface of the carbon plate in the form of hydrogen and ammonia bubbles. The loss of electrons to the hydrogen leaves the carbon plate with a positive charge. The zinc ions, Zn combine chemically with the

zinc plate. Thus the chemical action in the cell really produces electric charges which act like a pump in producing a continuous flow of electrons in any conductor joining its plates. The carbon is the + terminal of the cell and the zinc is the - terminal.

The accumulation of hydrogen bubbles over the carbon plate reduces both the voltage and the current. The hydrogen tends to set up an electromotive force in a direction opposite to that of the cell and thus decreases the effective e.m.f.; and it also reduces the conducting area of the plate and so increases the internal resistance of the cell. This action is called *polarization*.

Polarization may be remedied either by constructing the cell so that the electrolyte is mechanically agitated to free the hydrogen bubbles, or else to remove the hydrogen by causing it to combine chemically with a substance rich in oxygen, to form water. Manganese dioxide (MnO_2) is commonly used for this purpose, and it is called a depolarizer. (In the recent Air-cell "A" battery, oxygen is drawn directly from the surrounding air for this purpose.) The manganese dioxide is placed around the carbon plate. When hydrogen combines with its oxygen, water (H_2O) and Mn_2O_3 are formed.

If the zinc plate contains on its surface any impurities, such as iron, carbon, etc., each little particle of these impurities forms a tiny local cell with the zinc, causing the zinc to be eaten away whether the cell is delivering current to an external circuit or not. This is called *local action*. This may be reduced or prevented by using pure zinc (which is expensive) or by amalgamating the surface of the zinc with mercury. The mercury covers over the impurities.

The Dry Cell

There are many types of wet cells, and various electrolytes, plates and arrangements are used in them. In some applications, they are rather inconvenient to use as sources of e.m.f. because they are not readily port-

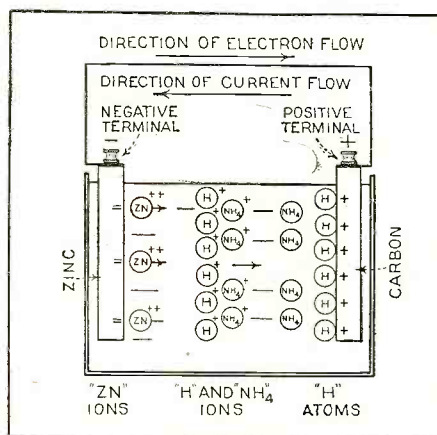

Figure 1. Wet primary cell

chlorine ions Cl to form zinc chloride (ZnCl_2) (a white substance). Thus the zinc plate is gradually used up to form zinc chloride during the normal operation of the cell. This zinc chloride stays in the solution.

The chemical action in the cell results then, in leaving too many electrons on the zinc plate and too few on the carbon. The overcrowded electrons on the zinc plate repel each other and try to push each other off the plate. This push, together with the attraction of the positive carbon plate, is the electromotive force of the cell. This e.m.f. will cause an electron flow around through the external circuit from the negative zinc plate through the wire to the positive carbon plate. This is equivalent to saying that an electric current flows from the carbon plate through the external circuit to the negative

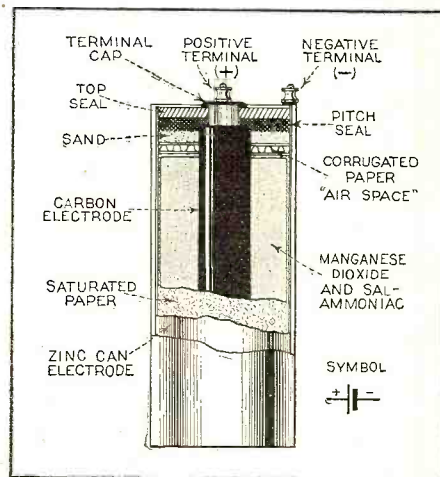

Figure 2. Interior of an ordinary 6-inch dry cell

* Radio Technical Pub. Co. Publishers' Radio Physics Course.

Physics Course

AND ELECTRIC CIRCUITS

Ghirardi*

aspects of radio phenomena. It contains teachers and students in high schools and in laying out current class assignments

able and are rather messy, due to the liquid. The so-called *dry cell* is a more convenient form of primary battery in many cases. With the perfection of the new low-filament-current vacuum tubes, the use of dry cells, and the new Air-cell battery to be described later, should increase greatly. They may be used as sources of filament current in the battery-operated receivers used in the nine million or more homes in the rural districts where ordinary electric-lighting circuits are not available for operating radio receivers.

The dry cell is not entirely dry, for it contains the electrolyte soaked up into a porous mass in the cell. Its elements are similar to the wet cell just described. However, the cell may be used in any position without spilling its contents. The dry cell consists of a zinc can which acts both as a container for the various parts inside and

the tops of the carbon rod and the zinc can for convenience in connecting wires to them. The carbon rod is the *positive electrode* of the cell while the zinc can is the *negative electrode*. Surrounding the rod is a quantity of powdered manganese dioxide sometimes mixed with granulated carbon. This acts as the depolarizer. The granulated carbon, manganese dioxide and the blotting paper are saturated with a solution of ammonium chloride (sal ammoniac) and water. This is the electrolyte.

Upon the top of the mixture is placed a piece of corrugated paper and then a layer of sand. Over this is poured melted pitch or sealing wax, which acts as a seal to prevent evaporation of the liquid from the cell. Caution should be exercised to prevent this sealing compound from becoming cracked, and the cell should not be placed in a very warm place for it would then soon become dry and inactive. The entire cell is placed in a cardboard container which acts as a sort of insulator to the outside of the zinc can.

The chemical reaction taking place during operation of this type of cell is: $Zn + 2MnO_2 + 2NH_4Cl = Mn_2O_3 + H_2O + 2NH_3 + ZnCl_2$. Thus Zinc chloride ($ZnCl_2$), and water (H_2O) and ammonia gas (NH_3) are formed by the chemical reactions.

In this type of cell the chemical action causes a slow eating away of the zinc, and the life of the battery is, theoretically, until this zinc is entirely gone. This is not quite true, actually, because before this happens, the internal resistance of the cell rises, due to the failure of the depolarizing agent to fully neutralize the hydrogen. This continues until the electromotive force is insufficient to overcome the resistance. So we see that the larger the cell, the greater its useful life is.

The voltage is about 1.5 volts per cell when new, and this is true whether the dry cell be a very small one such as is used in small "B" batteries, or a large 6-inch dry cell. The e.m.f. of a cell depends only on the materials used in its construction and not on the size.

Such batteries are rated at a definite maximum current discharge rate, so that the depolarizing effect will have a chance to keep step with the hydrogen liberation. This rating should never be exceeded for any appreciable length of time, lest the cell be ruined. The normal discharge rate for a 6-inch dry cell used as an "A" battery is between $\frac{1}{8}$ and $\frac{1}{4}$ of an ampere. Dry cells are adapted only to intermittent service conditions where they will be given a chance to recuperate by the action of the depolarizer on the hydrogen film.

Dry cells deteriorate when not in use, the smaller sizes having a shorter "shelf life" than the larger sizes. A dry cell becomes exhausted as soon as the electrolyte has been consumed and the inner surface of the zinc container has changed to zinc chloride.

Connecting Dry Cells

The e.m.f. of a dry cell in good condition
(Continued on page 304)

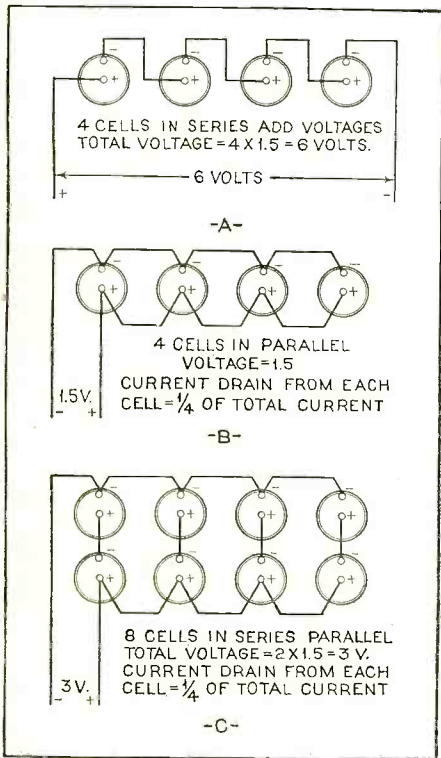
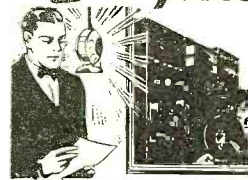

Figure 3. How battery cells may be connected for high voltage, high current drain, or both

also as one plate of the cell. The sectional view of Figure 3 shows both the internal construction and the outside view of a standard 6-inch (6 inches high) dry cell. The zinc container is lined with absorbent paper (like blotting paper) which serves to insulate the zinc from actual contact with the interior elements, to prevent a short circuit. The electrolyte soaks into, and thus filters through, this blotting paper lining. In the center of the can is the carbon rod which does not extend quite all the way to the bottom. Binding posts are fastened to

Come to Los Angeles!
4 full courses
at price of single course



Save money by enrolling in National Now. For single tuition fee, we now offer the four complete radio, electrical, television, talking picture and broadcasting courses. Four courses for price of one.

LEARN
RADIO-ELECTRICITY
TELEVISION-TALKING PICTURES
and BROADCASTING

No longer is it necessary to pay several tuitions. Now, for the first time in history, National offers complete training in Radio, Electricity, Television, Talking Pictures and Broadcasting all at a single tuition fee. When you enroll at National, these four full and unlimited courses of training will be given, enabling you to qualify for good jobs. We train you in four big pay trades; award you a life scholarship and help assist you to get a job that will start you on the road to big pay and independence for the rest of your life. Individual, practical instruction. Right NOW while jobs are almost impossible to "land" by the untrained man, you can get TRAINING for the lowest tuition fee ever offered. This is a limited offer, but you must act NOW!



Electricity

Become an electrical expert. Complete electrical machinery and equipment for you to work on at National.

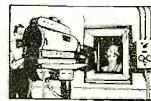

Television

The newest trade, with a tremendous future. Latest scanning disc equipment. National pioneers in this interesting work.

Come to Los Angeles, the center of radio and electricity—and where the great American television laboratories are located—where hundreds of trained sound engineers and mechanics are employed in talking picture studios. Thousands of dollars invested in new training equipment, by National for you to work on.

Largest and Oldest Trade School in West

For 27 years National has successfully trained men by practical shop methods. Previous education unnecessary. More than 25,000 graduates.

Railroad Fare Allowed to L. A.

For a limited time we will allow coach railroad fare to Los Angeles from any point in the United States. This is deducted from the tuition, so the trip costs you nothing.



Talking Pictures

10,000 theatres equipped for actual Good pay. National - trained men preferred in studios and theatres.

Free Employment Service

Spare time jobs while at school. We help you get a job to pay living expenses while learning. Our unlimited employment service will help you get a JOB after you graduate. A few delightful months of training and you are qualified.

NATIONAL RADIO & ELECTRICAL SCHOOL

Radio, Electricity, Television, Talking Pictures and Broadcasting

Dept. 1111-E, 4066 S. Figueroa, Los Angeles, Calif.

MAIL THIS COUPON FOR FREE DETAILS

This coupon will bring you our big, free training book if you are interested. It gives full details of the 4 big courses—radio, electrical, television, talking pictures and broadcasting; also details about railroad fare offer.

Name.....

Address.....

Town..... State.....

Backstage in

Personal interviews
with broadcast artists
and executives

By
Samuel Kaufman



THE THREE KEYS

most sensational dance orchestra conductors on the air. Guy began studying the violin while still a small boy in London, Ontario. It was not long before he interested his three younger brothers—Carmen, Liebert and Victor—in music, and the four brothers soon gave their home town a new style of music. Guy rebelled against the hot type of jazz and sought a tempo which pleased him. Unaware of its full value, he stumbled across the soft legato tempo which later won his musical organization many honors. Their radio popularity on the weekly Robert Burns Panatela program has been widened through many vaudeville and hotel bookings. In their early days, the Lombardos charged fifteen dollars for a private dance performance. The orchestra was augmented and the boys started climbing the ladder to stardom. After a season at a five-cents-a-dance place in their home town, they experienced a big triumph at a Lake Erie resort. Next came a vaudeville tour and the title of Royal Canadians was adopted for the act. Their success at a Chicago café was spoken about in New York, and they received an offer to fill an engagement at the Hotel Roosevelt. The microphone brought the Lombardo efforts to the ears of the nation and the conductor's popularity became nation-wide in scope.

GUY LOMBARDO



NANCY GARNER, a cousin of Speaker John Nance Garner, Democratic nominee for the Vice-Presidency of the United States, recently started a new series of broadcasts over the NBC. Miss Garner, a coloratura soprano, is a native of Corsicana, Texas. She played leading rôles in the musical comedy successes, "Rio Rita"

A UNIQUE Negro trio known as the Three Keys—Bon Bon, Slim and Bob—recently arrived at the NBC and received an unprecedented welcome by network officials, who were greatly impressed with the team's ability. They were immediately assigned a four-times-a-week billing. The trio came to radio from a basement café in Chester, Pennsylvania. They originated their unique method of harmonizing from the combined rhythms of the old South, modern Harlem and Broadway. Bob, the pianist of the program, has played the instrument since childhood. He was once a star pitcher for a Philadelphia colored ball team. He is a tenor in the trio. Slim, the guitarist and baritone of the program, also learned the melodies of his race which have been passed down through generations. Yet, he injected a modern type of rhythm into his music. Bob and Slim met a few years ago in a Chester roadhouse. They formed a team and were playing in a grill in the town's Negro quarter to large crowds. Bon Bon then came along and the duet was replaced by a trio. Bon Bon's tenor voice seemed to be just what Bob and Slim were seeking in order to develop their new style of entertainment. They were singing over a Philadelphia station when a representative of the NBC Artists Service heard the program. A short time later the Three Keys found themselves booked in a featured spot in the New York studios of the NBC. They "clicked" right from the start.



CLIFF EDWARDS

CLIFF EDWARDS, the "Ukulele Ike" of musical comedy and talking film fame, has signed an exclusive contract with the CBS and is presented over that network on a permanent schedule. He is accompanied by Nat Brusiloff's Orchestra, which, to blend with Edward's style, has been stripped of its brass section. The response to his surprise appearance on an unannounced program resulted in a long-term radio contract. Thus the ukulele-strumming singer is in the ranks of those comparatively few entertainers who have successfully scored in the three great fields of the stage, the screen and the radio. Edwards made his musical comedy debut in the Ziegfeld Follies of 1919. This was followed by featured billings in "Lady, Be Good," "Sunny," "No Foolin'" and the Ziegfeld Follies of 1927. The advent of talking pictures found him in Hollywood, where he appeared in numerous pictures under the Metro-Goldwyn-Mayer banner.

SUCCESS came early in life to Guy Lombardo, conductor of the Royal Canadians of the CBS. At 29, Lombardo is one of the

FREE
This 104 Page
Radio Dealers'
and Service-
men's Buying
Guide
Over 3,000
Items

send for
this
**NEW
ISSUE**

**RADIO
BARGAIN
NEWS**
Direct & 101 New
Items Page 104

Lowest Wholesale Prices

If you are a professional radio man, whether a dealer, a serviceman, experimenter, or public address engineer, you should secure a copy of this valuable book at once. It will save you from 25 to 50% on your purchases.

14 Pages of New
Public Address Equipment

New Amplifiers—New Receivers—
New Tubes
Everything that's new in Radio

Federated Purchaser Inc.
NEW YORK, N. Y.
25 PARK PLACE DEPT. 7
Please mail me Catalog A.
Name.....
Address.....
or pin this coupon to your business card.

SEND COUPON!

**BUTTON HOLE MICROPHONE
MICROMIKE***



The ideal microphone for all types of Public Address Systems or any acoustical application such as broadcasting or home recording.

Small in Size—Light in Weight
Perfect Reproduction

Introductory Price . . . \$10.00

Write for Bulletin

RADIO RECEPTOR CO. INC.

Sole Manufacturers

106 - 7th Avenue New York, N. Y.

* Registered U. S. Patent Office

Jobs—Servicemen
THE TRIMM "SPECIAL DEPENDABLE" Guaranteed Headset is the best phone you can buy for Hospital Installations. Bakelite shell and cap, forced magnet, all inside terminals, moisture proof cord.
List Price only \$3.00.

TRIMM RADIO MFG. CO.
"Earphone Specialists"
1528-38 Armitage Ave., Chicago, Ill.

RADIO SCHOOL

YOUNG MEN wanted to train as radio operators; we prepare for U. S. Govt. license; call or write for 40-page catalog; established 1899. Oldest, largest and best equipped school. Investigate.

MASS. RADIO SCHOOL
18 Boylston St. Boston, Mass.

Broadcasting



NANCY GARNER

and "The Desert Song." Her stage appearances were made under the professional name of Margaret Miller. She toured the Public Theatres' southern circuit and, during the last five years, has been featured over several southern stations. Until her recent affiliation with the NBC, Miss Garner had never appeared on a network program. Miss Garner obtained her early education in Texas. She was a Texas entrant in a Chicago contest and was awarded two scholarships to the Chicago Musical College. Upon her homecoming, the Federated Music Clubs of Texas sponsored a benefit performance so that she might continue her studies in New York. Miss Garner's radio programs include a varied repertoire of classical, semi-classical and "blues" numbers.

ARTHUR TRACY, the CBS Street Singer, achieved new heights of stardom when he was recently selected to star in the Chesterfield "Music That Satisfies" programs over the network. Tracy's unique style of radio singing won him lucrative stage and screen contracts which have kept him quite busy in recent months. The Street Singer's hobby is languages, and after many years of impromptu study, he is said to be one of the best linguists in the Columbia studios. Since childhood Tracy has collected scores and recordings of his favorite music. His library contains over 35,000 different numbers, with about 600 foreign works included. He has memorized about 400 of the foreign works and seldom has to refer to a score in building his programs. Tracy's early pro-



ARTHUR TRACY

Chatty bits of news on what is happening before the microphone

essional activities were confined to stock companies and little theatre productions. On the new Chesterfield series, Tracy is heard Tuesday and Friday nights.

ADDED to the list of newspapermen who have become established microphone stars is the name of Edwin C. Hill, star reporter of *The New York Sun* for twenty-two years. Hill is now featured on the CBS three times weekly—Tuesdays, Thursdays and Saturdays—in a new type of commentary on news events. He speaks of timely public affairs, taking the radio audience behind the scenes with him and describing the personalities that are making the news. His talks are analytical to the extent that they include examination of news backgrounds as well as events. He was born in Indiana and is a product of Indiana University. After graduation, he joined the staff of an Indianapolis newspaper and, in 1910, came to New York and joined the staff of *The Sun*. During his long association with the newspaper he covered important assignments throughout the United States as well as abroad.



EDWIN C. HILL

The Sound Club, a social organization of national scope for members of the radio industry, was recently founded in New York. Its membership includes some of the most prominent names in all branches of broadcasting. Located in the three tower floors of the St. Moritz Hotel on Central Park South, the club's headquarters are one of the town's leading meeting places for artists and executives of the industry. The Sound Club maintains the loftiest broadcasting studio in New York, thirty-four floors above Central Park. Wire lines convey the club's special programs to the various stations in New York. Artists, engineers and manufacturers—important radio personalities of all branches of the industry—attend the round-table luncheons and other regularly scheduled activities of the club. While a guest at a recent round-table luncheon, we were impressed with the sight of groups of executives of competitive stations engaged in friendly, non-commercial chats at the tables. There are nine distinctive membership sections to the club. These are, namely: program, studio, technical, commercial, artists', announcers', public relations, equipment and organization sections.

STARTING on September 6 and continuing weekly until December 27, the National Advisory Council on Radio in Education and the American Political Science Association will jointly present a series of talks over the NBC on the subject of "You and Your Government," in which vital pre-election and post-election civic subjects will be discussed by eminent educators. The pre-election half of the series is sub-headed

The first Resistor Guide ever published



FREE with an order for 20 Metallized Resistors— or for Kit No. 1 or No. 2

—and still the LEADER

The I. R. C. Resistor Replacement Guide—bigger and more comprehensive now than ever! Last fall, 32 pages—this fall 88. Increases every month by four additional pages at no added cost to the owner.

Over 15,000 Servicemen use the I. R. C. Guide. Why? Because it gives them instantly, quantities of information they need in their daily work. Complete resistor data about any popular receiver—the value and code and position in the circuit of each defective unit. Price just the same as last year—\$1. Or you get the Guide Free by purchasing 20 Metallized Resistors— or I. R. C. Kit No. 1 or No. 2.



I. R. C. Handy Kit No. 1 contains 20 1-Watt Metallized units ranging from 500 ohms to 3 megohms.

I. R. C. Handy Kit No. 2 contains 20 2-Watt units, from 500 ohms to 1/2 megohm.

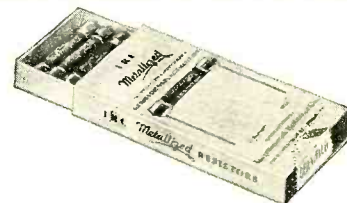

The I. R. C. Grid Bias Kit contains 10 assorted Metallized units and Power Wire Wound (5 Watt) types, required to bias the following tubes—'24—'26—'27—'71A—'10—'45—'50—'47.

Ask your jobber or write us at once for these time-saving kits or Resistor Guide. Get on the I. R. C. mailing list to receive other service helps.

INTERNATIONAL RESISTANCE CO.
PHILADELPHIA, PA. TORONTO, ONT.



Metallized

AND POWER WIRE WOUND—
PRECISION WIRE WOUND
RESISTORS

FOR BETTER RECEPTION

Order a Set of Centralab Motor Radio Noise Suppressors

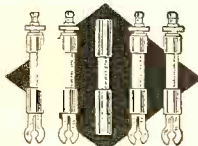

They're 50% to 500% more efficient in reducing spark noises. We're having a real job keeping up on production! They MUST be good... that's the only way we can explain their increasing popularity.

RETAIL PRICE	YOUR PRICE
set of 5 for 4 cyl. car \$2.00	\$1.10 net
set of 7 for 6 cyl. car \$2.75	\$1.50 net
set of 9 for 8 cyl. car \$3.50	\$1.90 net

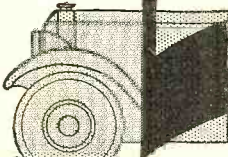

Centralab
CENTRAL RADIO LABORATORIES
MILWAUKEE, WIS.

FREE GET THIS QUICK



New and enlarged Summer edition of our Radio and Short Wave Treatise, No. 25, just off the press—100 pages chock full of useful information, radio items, diagrams and illustrations. Positively the greatest book in print—NOT JUST ANOTHER

CATALOG. Contains a large editorial section with valuable information not found anywhere else. Considerable space is devoted to a TREATISE ON SHORT WAVES for both beginners and regular "hams." Among the new technical information listed are the following: Modernizing old radio sets—repairing speakers and headsets—making superhets out of old sets—dots on constructing two-volt battery and automobile receivers—circuit of the famous Gernsback Megadyne One-Tube Loudspeaker Set—short wave coil winding data—discussion on S.W. adapters, converters and receivers, etc.; etc.

WRITE TODAY. Enclose 4 cents for postage. Treatise sent by return mail.
RADIO TRADING CO.
27 West Broadway New York City

VAN SHUNTS-DIALS RESISTORS
and parts for the
POCKET DIAGNOMETER
ORDER THROUGH YOUR DEALERS
If they cannot supply, send direct
D. L. VAN LEUVEN—Laboratory
410 East 15th St. New York City

"Government in a Depression" and will feature talks by a long list of prominent men in American affairs. The post-election part of the series is sub-headed "Constructive Economy in State and Local Government." A listener's handbook for free distribution has been prepared for the series. The handbook includes the complete program, outlines of subjects, a bibliography prepared with the assistance of the American Library Association, and suggestions for listeners. It is available upon application to the University of Chicago Press.

Radio Physics Course

(Continued from page 301)

is about 1.5 volts on open circuit. Due to its internal resistance, the terminal voltage drops when the cell starts to deliver current.

Testing a cell with a voltmeter is of no value when the cell is not delivering current, for even a cell that is almost entirely discharged will test close to 1.5 volts on open circuit. When delivering maximum current the voltage of a new cell should remain as high as one volt.

The method of testing dry cells in practice is to connect an ammeter of low resistance (less than .01 ohm) directly across the terminals of the cell. On short-circuit through the low resistance of the ammeter (having a scale reading up to about 50 amperes) a 6-inch dry cell will generally send a current of 25 to 30 amperes. Cheap pocket ammeters are sold for testing dry cells this way. The ammeter should be left across the terminals only long enough to take the reading. As a dry cell becomes old, its internal resistance increases, so that the amount of current flowing during the short-circuit test through the ammeter decreases. A 6-inch cell should be thrown away if it reads less than 5 amperes. Dry cells cannot be recharged, so they are called *primary* cells.

In all radio diagrams a single cell is represented by a pair of parallel lines. One is long and thin, representing the positive terminal, and the other is short and thick, representing the negative terminal. The symbol is shown in Figure 3.

If a higher voltage than 1.5 volts is required, a number of cells must be connected in *series*. The number of cells to connect in series in any case is found by dividing the total voltage required, by 1.5 (the voltage of a single cell). Thus if 6 volts are required, connect $6 \div 1.5 = 4$.

Parallel circuits are very common in radio receivers. In battery operated receivers the filaments of the various tubes are usually connected in parallel across the source of e.m.f. (battery).

Election Special

(Continued from page 289)

pay to use a transformer of poor design, especially as good audio transformers can be procured at very reasonable prices.

An a.c. on-and-off switch (S2) can be mounted either on the panel or at the side of the cabinet. In the latter case, one of the long-neck type should be procured. As can be seen in Figure 1, this switch controls the a.c. input to both the pre-amplifier and the power stage.

The output of the second -27 tube goes to the input binding post and is later connected to the input binding post of the power amplifier. The B positive side of the primary of the audio transformer is connected to the B positive binding post on the pre-amplifier and later goes to not less than 90 volts positive on the power amplifier. To complete the circuit, the common ground on the pre-amplifier is connected to the B negative binding post of the pre-amplifier and then to the B negative

post of the power stage. When using the amplifier, this binding post should also be connected to a good ground. This will eliminate whatever hum that may be had in the amplifier itself. Likewise, the center-tap of the microphone is grounded to eliminate any possible effect that touching the microphone may have in causing the amplifier to reach the point of instability.

The same problems that confront the users of larger amplifying systems also become evident with this outfit. The question of feed-back from the microphone to the speaker, for instance, must be dealt with in the same way. This can be overcome by placing the microphone at a good distance from the loudspeaker. The exact distance depends upon the immediate surroundings and can be determined on the spot. The microphone should always be placed with its back toward the loudspeaker. Where conditions do not permit wide separation between the loudspeaker and the microphone, the use of a highly damped microphone will prevent feed-back.

Once the serviceman is in possession of an amplifier of this type, its many practical uses will become more evident. There is a particular demand for public-address amplifiers in retail stores which are running sales. Among these can be found haberdashery

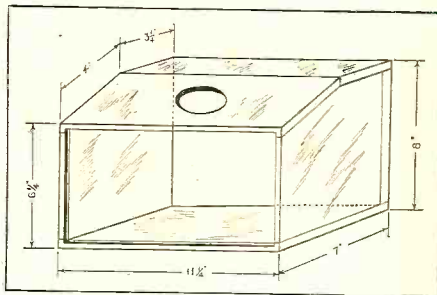

PRE-AMPLIFIER CABINET

Figure 2. Specifications are given here for a cabinet of neat and convenient design, to house the pre-amplifier

stores, jewelry auctions, cut-rate drug stores, etc. The power amplifier and speaker can be placed in the front of the store, facing the street, and the pre-amplifier at the rear, connected by a three-wire cable and a.c. connection. From the point at the rear of the store the outfit can be controlled while the merits of the store's commodities are being extolled. Rental prices for such work should run from \$5.00 up, depending upon the work to be done and the demand.

List of Parts

- C1, C2—5 mfd., 200-volt by-pass condensers
- J1, J2, J3—Single-circuit, closed phone jacks
- M1—Milliammeter, 0-25 mils.
- P1—Phone plug
- R1, S1—400-ohm variable resistor with switch attached
- R2—250,000-ohm variable resistor
- R3—50,000-ohm variable resistor
- R4, R5—2000-ohm, 1-watt resistors
- S2—a.c. switch
- T1—200-ohm microphone transformer
- T2—Audio transformer, 3-1 ratio
- T3—Filament transformer, 2.5-volt
- Panel and cabinet
- 6 binding posts
- 2 UY sockets equipped with type -27 tubes
- 2 phone tip-jacks
- 1 battery (3 or 4 1/2 volts, for microphone supply)

Accessories

- 1 Kolster type K-5, 210 power amplifier with built-in B supply and dynamic speaker
- 1 microphone, double-button
- 1 phonograph pick-up, high-impedance type
- 1 electric phonograph turntable

?QRD?

*A column devoted to the commercial operator and his activities
Conducted by GY*

WELL, well, the broadcast boys have been walking around with round shoulders working fast to meet the requirements of the Federal Radio Commission's edict that all broadcast stations must be equipped with precision apparatus capable of maintaining their allocated frequency not to be plus or minus that frequency by more than 50 cycles. And I worry!!

Holding down the ship over at WNYC Bob Dickens, (TD) (no, not related to Charles) the former speed artist of the Florida and Freddy Ulrich (BU) he of the short-wave complex, are still battlin' over the foggy merits of the Big Outside and the "ould Nyvy." Fred took "time out" to remember when Katzenberger kicked him in the slats for shoving a pencil under the clacker switch on the charging panel to hold it up—not knowing the fuse had blown. He still can't savvy why old Katz didn't blush on payday 'cause, like BU sez, "What a gun-stock and golf-club carver that guy wuz."

So long as there is a wave-band left open, Hams will keep on QSOing and experimenting. Lester Spangenberg, whose most interesting articles in this magazine have almost killed the Sandman for you, is still an active amateur, and, as he sez, "more active today than when I worked with a spark coil back in 1906." His call W2MB on the 40 and 20 meter bands, both telegraph and telephone, is well-known throughout the world. Just a young fellow in his enthusiasm and sympathy for amateurs, he invites all to work him but requests to "please stick to the frequency and not slide off."

Here's how. . . O. A. Wyckoff, who, as some of you may remember, did a hitch in the Navy in 1906, is now trying to sell lots of lots and "all the trimmings" in Bellmore, Long Island. . . Here's a letter from Benny Wolf, who is monitoring at Grand Island, Nebraska. . . Charlie Thevenet, who is strutting his stuff on the operating staff of WOR, would like to hear from some of the old gang. . . H. K. Dreisbach sends 73's to all. . . Well, well, well, if that big brute, Al Northstrom, hasn't come up from the dead. He sends his 73's from the U.S.S. *Tulsa* and says he'd like to hear from the gang. . . and Dick Hoyt is with the American Airways Company at Boston Airport and yodels "how-de."

Mr. E. J. Greco, better known to the proletariat as EG, came up out of the ether showing his famous smile and unblushingly extravagant about his 2BJM station. On 40 meters the CW blooperline is radiatin' plenty and bringing 'em in like nobody's business and sez he wants to work with the rest of the gang. Also, wants to hear from the old bunch who remember him as an "op" before he got Ass't Engineer of WHN printed alongside his cognomen. Give him a yell.

Say, do any of you bright boys remember back in '28 that one about the steward who accidentally became an Op and who didn't know the difference between a condenser and an accordion? Well, Little Boy Blue ambles into the Buzzer room at 75 Varick Street the other day, and there sits the hero of the episode, Artie Finch, peacefully and calmly biting his fingernails, waiting to be called. All your perspiring correspondent could worm out of him was "Well, it happened this-a-way—but my lawyer said—" Darn these modest guys anyho! But the old proboscis (snozzola, if you must) is to the ground, and I'll get the inside details even if I have to buy him a drink.

We remember In Memoriam, Jack Phillip, Chief Op, who stuck to his post when the *Titanic* went down. The spirit still is "carrying on."

*The strain at the board isn't easy,
Those eight hours never seem done—
And at zero degrees 'tisn't breezy,
You never can conquer the sun.*

*At night when the tempest is screaming,
When combers fly over the rail,
Vigil, alert, senses gleaming,
With spirit while others are pale.*

*The last man to leave when there's danger—
Our radio men know no fear;
Their stories untold are much stranger
Than many a great author's sphere.*

Radio activities have developed to such an extent that there are few organizations in the country which cannot find room for a radio-trained man. From the moving-picture industry to intercommunication systems, the need for radio men is becoming more and more apparent—and with this understanding growing, there are many of the world-wide "Brotherhood of Brass Pounders" who may know some organization who is in need of an experienced, intelligent man. This column appeals to them to shoot their information in so that we can put it in the hands of those gadgets who, through no fault of their own, are "on the beach, high and dry."

Cheerio and toodeloo, gang, and 73's. . .

Pocket Diagonometer

(Continued from page 291)

resistance in the circuit. A good plan is to solder wires about 10 inches long to each of the switch terminals to be used before mounting the switches on the panel. Then carefully clean all contacts with fine sandpaper. If possible, it will also be found worth while to dip the entire switch unit in gasoline to remove any oil or grease that may have worked into the contacts.

Before mounting the meter on the panel, the special dial should be installed. This is accomplished by removing the meter from its case. Then remove the two screws that hold the old dial in place and slide the new dial in on top of the old one. The screws should then be replaced and the meter put back into its case.

It will be easy to follow the schematic wiring diagram of Figure 5 if it is remembered that the inner switch points and the inner contact arms are those which lie closest to the panel. Keeping this fact in mind, the constructor should have no difficulty in wiring the entire unit without further written instructions.

The only other points which seem to call
(Continued on page 309)

A new Tube-Seller



with proven profit-making features

The new Weston Model 677 Tube-Seller makes the exclusive features of the Weston-Jewell design available at a cost so low that no dealer or serviceman can afford to be inadequately equipped.

Such proven features as the direct reading three-color tube performance meter, zero-reset test circuit, line voltage indicator and compensating control are combined in the new Model 677. Furthermore your investment is protected by a unique arrangement of spare sockets for use as new tubes are developed.

Ask your jobber to show you one of these new Weston Tube-Sellers!

Pattern 675 Tube-Checker



A compact, light weight tube-checker that is popular for both portable and counter use. Test limits are etched on the instrument panel for quick reference.

All present tubes are tested without the use of adapters. Models are available for both 25 and 60 cycle power supplies.

WESTON JEWELL

Weston Electrical Inst. Corp.
Jewell Electrical Inst. Co.
615 Frelinghuysen Ave., Newark, N. J.

Please send me information concerning the complete Weston-Jewell line of radio service instruments.

Name.....
Address.....
City..... State.....

A NEW WAY TO LEARN THE CODE

ANNOUNCING NEW MASTER TELEPLEX

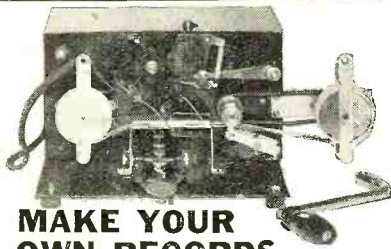

MAKE YOUR OWN RECORDS

The new MASTER TELEPLEX records your own sending in visible dots and dashes and then repeats it to you audibly on the headphones.

5,000 words on each tape and the number of tapes unlimited.

This marvelous new invention makes learning the code an exceedingly pleasant task. No previous experience necessary. Anyone can master the code and pass government examinations very quickly.

The new MASTER TELEPLEX is the only instrument ever made that will record your own sending and then repeat it back to you exactly as it was sent. Radio and Electrical Engineers agree that this is the most marvelous instrument of its kind ever produced.

Write today for booklet R-11. It is free and places you under no obligation.

TELEPLEX CO. 76 CORTLANDT ST. NEW YORK, N. Y.

FAKE CALLS OVER YOUR OWN RADIO

Cut in on broadcasts. Wild stories, imaginary news items, remarks about your friends. Packed with fun-making possibilities, the World Microphone is easily attached and always ready for use. Hidden in another room you can put your pranks and wise-cracks "over the air" through your set. Order today—start the fun.

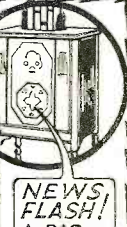

Special Only \$1.00
1 POST PAID
C. O. D.
22c Extra

WORLD MICROPHONE CO.
Dept. 103, 718 Mission St., S. F., Cal.

Write Today PATENTS

TIME COUNTS IN APPLYING for patents. Send sketch or model for instructions or write for free book, "How to Obtain a Patent" and "Record of Invention" form. No charge for information on how to proceed. Clarence A. O'Brien, Registered Patent Attorney, 3098 Adams Building, Washington, D. C.

PATENTS

Write for Free Information. HOW TO OBTAIN A PATENT and RECORD OF INVENTION—or send drawing or model for examination. **MILLER & MILLER, Patent Attorneys** FORMER MEMBERS EXAMINING CORPS U. S. PATENT OFFICE 1006 Woolworth Bldg., Dept. H, New York 206 Earle Building, Washington, D. C.

PATENTS TRADE MARKS COPYRIGHTS

"Little Ideas May Have Big Commercial Possibilities" PROTECT THEM BY PATENTS Send for our Free book, "HOW TO OBTAIN A PATENT" and "Record of Invention" blank. Prompt Service—Reasonable Charges—Deferred Payments. HIGHEST REFERENCES **VICTOR J. EVANS & CO** Registered Patent Attorneys—Established 1898 622-L Victor Building, Washington, D. C.

Latest Radio Patents

A description of the outstanding patented inventions on radio, television, acoustics and electronics as they are granted by the United States Patent Office. This information will be found a handy radio reference for inventors, engineers, set designers and production men in establishing the dates of record, as well as describing the important radio inventions

By Ben J. Chromy*

1,860,114. OSCILLATION GENERATOR. KINJIRO OKABE, Sendai, Japan, assignor to General Electric Company, a Corporation of New York. Filed June 13, 1928, Serial No. 285,008, and in Japan July 1, 1927. 6 Claims.

1. The combination, in an oscillation generator, of an electron discharge device comprising a cathode, a plurality of plate-

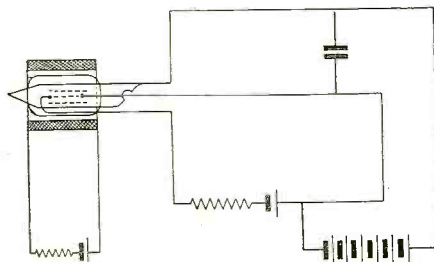

like anode members arranged around and substantially enclosing said cathode, means for producing a magnetic field between said members and parallel with said cathode, a connection between each of said members and said cathode including a source of potential and a connection between said members whereby high frequency oscillations are produced, said last connection being variable to affect the oscillations produced.

1,850,267. PHOTO-ELECTRIC MUSICAL INSTRUMENT. FRANÇOIS CHARLES PIERRE HENROTEAU, Ottawa, Ontario, Canada. Filed Feb. 7, 1930. Serial No. 426,718. 7 Claims.

5. In an apparatus to reproduce the notes of a musical instrument, transparent members having printed thereon the oscillations corresponding to a given note, means to illuminate through said members photo-electric cells by means of a traveling light beam, members of graduated transparency to selectively control the brilliancy of the beam, electro-magnetic means to actuate the graduated members and permit operation thereof at an exact predetermined point of the transparent members, and a timing mechanism whereby any given note may be rapidly repeated or sustained at will.

1,850,811. RADIO RECEIVER. EINAR H. SELVIG, Tacoma Wash. Filed Mar. 17, 1931. Serial No. 523,361. 1 Claim.

In combination in a radio receiver, an alternating-current power equipment, power lead-in wires to said equipment, a first-stage radio transformer having a two-coil primary, an insulator between said primary coils, supplementary lead wires from said power lead-in to each of said primaries, a circuit bridging each of said primaries, a potentiometer, and a set of four fixed condensers, the potentiometer located centrally and common to

each of the four circuits, one of the said condensers located in each of the aforesaid cir-

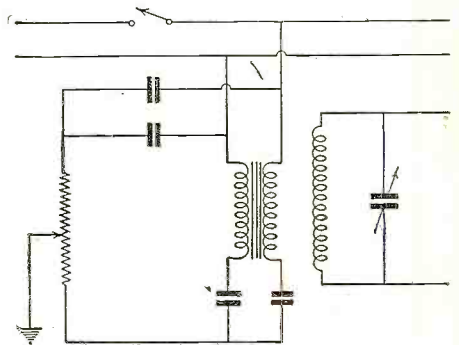

cuits between the potentiometer and the terminals of the primary coils, and a conductor connecting the sliding contact member of the potentiometer to ground.

1,851,587. AMPLIFIER SYSTEM, METHOD AND APPARATUS. EDWARD H. LORTIN and SIDNEY Y. WHITE, New York, N. Y., assignors, by mesne assignments, to Radio Corporation of America, New York, N. Y., a Corporation of Delaware. Filed July 22, 1927. Serial No. 207,618. 18 Claims.

1. The method of selectively amplifying alternating currents which comprises selec-

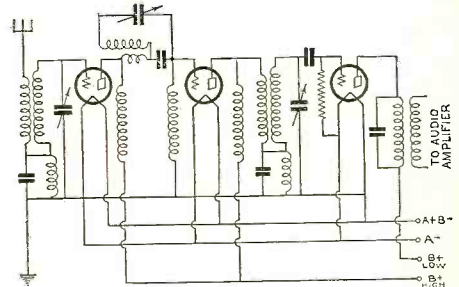

tively impressing said currents upon a three-electrode vacuum tube, non-selectively transferring the tube output of said currents to a second tube, and selectively controlling the amplifying ability of said first tube independently of said step of selectively impressing said currents upon a three-electrode tube.

1,860,050. OSCILLATION GENERATOR. MENDEL OSNOS, Berlin, Germany, assignor to Telefunken Gesellschaft fur Drahtlose Telegraphie m. b. H., Berlin, Germany, a Corporation of Germany. Filed Oct. 1, 1929, Serial No. 396,445, and in Germany Sept. 27, 1928. 1 Claim.

A generator for producing simultaneously a plurality of carrier waves of slightly different frequencies comprising an electron

* Patent Attorney, Washington, D. C.

Aero International All Wave 11 Tube Super-Hetrodyne DeLuxe

Explore the world with the Aero International 15 to 550 Meters

The greatest radio value every offered. At last! World wide loud speaker reception at a sane price. One dial control. Designed so any novice can get maximum results on both short and broadcast bands. This is not a converter and broadcast chassis. It is one receiver covering all wave lengths. 2 Sets in one. Besides your regular broadcast band also receives Foreign programs, Amateurs, Police, Ships at sea and Aeroplanes. Employs the latest type Super-Phonic Tubes. Completely assembled with 2 full dynamic speakers, Less Tubes. **\$29.75**



Aero 4 Tube Set
The lowest priced quality Midget Receiver on the market today. Price \$10.90 less Tubes. Complete set of new Super-Phonic Tubes \$2.95. This wonderful distance getter is equal in performance to last season's 5 Tube Pentode Sets.



Aero 6 Tube Super-Hetrodyne Automatic Volume Control

Employs the latest tubes. Guaranteed Coast to Coast reception. Price \$18.50 less tubes. Tubes \$4.50. Split Hair Selectivity. Phonograph Pickup Connection. 7 Tuned Circuits. Composite First Detector and oscillator followed by 2 stages of 175 K.C. intermediate amplification.



Aero 5 Tube Set Latest Super-Phonic Tubes

Guaranteed Coast to Coast Reception. Price \$11.90. Split Hair Selectivity. Tubes \$3.75. Phonograph pick-up connection. Single illuminated full vision travelling spot light dial. Mellow Tones. Full Dynamic Speaker.



Aero 1 Tube Short Wave For Head-phone Operation. \$5.95

Listen in DIRECT to London, Paris, Berlin, Buenos Aires and other broadcasting stations throughout the world via short waves. Your ordinary receiver cannot tune in these low wave stations. 14 to 550 meters. AERO 2 Tube Short Wave Set \$8.95. Same as above set but it has one stage of Audio Frequency added to it.

Full Dynamic Speaker.

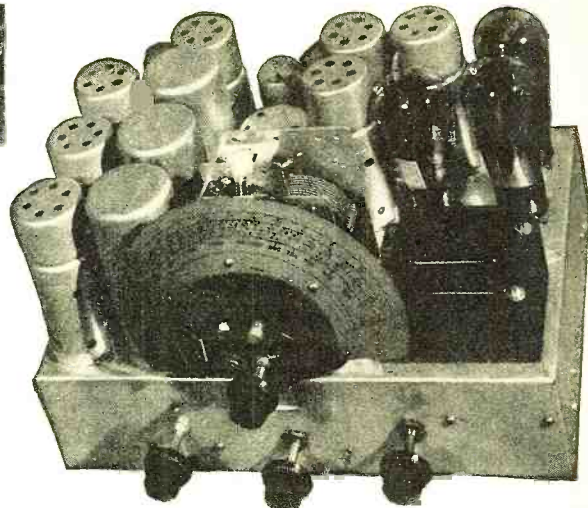

Auto Radio. Price of Set, Remote Control & Dynamic Speaker \$19.75 less tubes and batteries.

Aero Pentode Auto Radio SUPER-HETRODYNE

New 1933 Model. Latest type tubes. At last! The perfect



Aero Pentode Power Amplifier for Public Address systems and Sound Trucks. Price \$9.85



\$12.50 Aero Super-Hetrodyne Converter

Convert your A. C. Radio Set into a Short Wave Super-Hetrodyne. 15 to 200 meters. Price \$12.50.

Write For Complete Catalogue of Sets and Parts

CHAS. HOODWIN CO.,

4240 Lincoln Ave.,

Dept. Y-3, Chicago, Illinois

discharge device, and an input circuit therefor comprising a plurality of parallel tuned circuits tuned to different frequencies, scri-

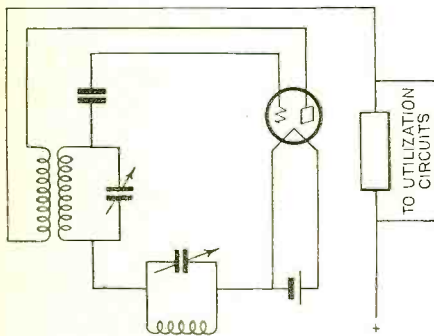

ally connected together, and, a tuning condenser connected in series with the tuned circuits.

1,851,658. TUBE CHECKER. Job R. BARNHART, Lakewood, Ohio, assigner of one-half to Walter M. Scott, Lakewood, Ohio, and one-half to Raleigh E. Tresise, Cleveland Heights, Ohio. Filed May 10, 1928. Serial No. 276,575. 8 Claims.

1. A device for indicating interelement short circuits in three-element vacuum tubes comprising a tube socket adapted to receive a tube to be tested, a transformer, a meter, the said meter, transformer and socket being electrically connected with a source of current in such a manner as to impress different voltages on said meter to move the indicating element thereof different distances upon short-circuits between different pairs of said elements.



"We Cooperate, but We Never Compete"

The Webster-Chicago policy toward distributors, service men and sound contractors is most liberal. While we cooperate fully with engineering advice and recommendations, we do not in any way conflict or compete with the direct contracting of individual installations. You may consult with Webster on public address or sound amplifier problems in fullest confidence.

Write for Our Catalog

Our new catalog describes the full line of Webster-Chicago amplifiers, public address systems and accessory equipment. In addition, there are valuable suggestions for installation and uses. Write on your letterhead.

THE WEBSTER COMPANY
858 Blackhawk St. Chicago, U.S.A.

Export Dept. 308W. Washington St., Chicago

Webster-Chicago Sound Amplifiers



WEBSTER CHICAGO

SERVICEMEN!

Have you seen John F. Rider's Perpetual Trouble Shooter's Manual Volume No. 2

Brand New. The Finest manual available in the industry. No duplication of material found in Volume No. 1. Atwater Kent electrical values in Volume 2. Also point-to-point resistance data in Volume No. 2.

Sold with money back guarantee. Price \$5.00.

See it at your dealer's. If he does not have the Manual write to us for descriptive literature.

RADIO TREATISE CO., Inc.
1440 BROADWAY NEW YORK CITY

The Voltage "POLICEMAN" in Your RADIO

Better reception for Radio Owners. Good profit for Servicemen. Send \$1.40 to Dept. R-11 for sample and sales helps.



AMPERITE Corporation
561 BROADWAY, NEW YORK
AMPERITE
Self-Adjusting
LINE VOLTAGE CONTROL

for INVENTORS, EXPERIMENTERS

CATHODE RAY HANDBOOK



HOW TO USE
CATHODE
RAY TUBES
for
NEW DEVICES,
MEASUREMENTS,
MACHINES,
TESTS
and
TELE-
VISION

Cathode Ray Tubes open way to

a tremendous field of invention, discovery and investigation. The key to Television, these tubes also have unlimited commercial applications. These tubes, now available at nominal cost, make electric currents, sound waves, and secret movements visible to the eye, introduce new means for microscopic measurements, new methods for mechanical and electrical tests.

This Handbook written by Henry M. Lane, former instructor at Mass. Institute of Technology, is intended for students, inventors, experimenters. Gives full data on sweep circuits, power packs, and also information on Thyratron tubes.

Price 50¢ postpaid

Send cash, stamps, or money order

**GLOBE TELEVISION AND
PHONE CORPORATION**

57 Haven Street, Reading, Mass.

Runs Sound Equipment or Midget Radio in Your Car

Just the thing you have been looking for. New and unusual. Opens up a field of real pleasure or real profit.

The U-10 Dynaverter

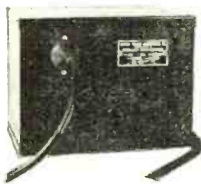

will operate any 110 volt A. C. 60 cycle appliance drawing up to 65 Watts, from any automobile storage battery. No need to buy any other equipment. Especially designed to operate the U-9 Portable Public Address System. Net price of U-10 Dynaverter only \$21.00.

Send for Full Particulars

on U-10 Dynaverter and the U-9 Portable Public Address System.

We also carry a complete stock of Radio Replacement parts. Send for Free Catalog—

LEW BONN CO.

2484-2486 University Ave. St. Paul, Minn.

SERVICEMEN-DEALERS

Write for our Catalogue
Complete Stock of NEW
Radio Replacement Parts

Hard to Get Parts—We have them. Send us your repair work for estimate.

Grant Radio Laboratories

6521-N South Halstead St., Chicago, Ill.

TAU-REX CONVERTS

Any D.C. Milliammeter Into a Sensitive A.C. Meter. A New Copper-Oxide Rectifier—MADE FOR METERS—Size 3/4 in. by 1/4 in. FULLY GUARANTEED.

Can be used in set testers, analyzers and for many other purposes. See T. S. Goldman's article on "Handy A.C.-D.C. Set Analyzer Multimeter" in September issue of Radio News. Tau-Rex will be shipped postpaid promptly upon receipt of \$3 (check or money order)—or order C. O. D. and pay postman. Furnished Complete with Diagrams and Instructions.

LEO TAUSSIG, 3245 37th St., Long Island City, N.Y.

What's New in Radio

A department devoted to the description of the latest developments in radio equipment. Radio servicemen, experimenters, dealers and set builders will find these items of service in conducting their work

By The Technical Staff

Pre-Amplifier

Description—A four-position microphone mixing panel and pre-amplifier, designed for use with public-address systems, centralized radio, broadcast stations or wherever sound distributing systems are employed. It has provisions for mixing the output of either carbon or condenser type microphones or



low-impedance radio or phonograph pick-up. The input has provision for four 200-ohm center-tapped circuits. The impedance of the output circuit is 200 ohms but can be designed for special impedances upon order. The complete unit is housed in a steel case measuring 8 inches by 9 inches by 1 9/16 inches. The total weight of the device is 27 pounds.

Maker—The Webber Company, 850 Blackhawk St., Chicago, Ill.

Portable Oscillator

Description—The model 175 oscillator is designed for the following intermediate-frequency ranges: 170 kc. to 185 kc., 127 kc. to 133 kc., 254 kc. to 266 kc. Frequencies between 550 to 1500 kilocycles for the broadcast wavelengths can be obtained by

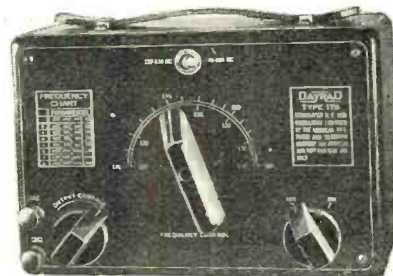

means of harmonics. The instrument is equipped with a shielded dummy antenna and an input adapter. The variable output control mounted on the instrument panel governs the amount of radio-frequency energy to be supplied to the receiver. The vacuum tube and batteries are enclosed in a cast aluminum case measuring 8 1/2 inches long by 6 inches high by 5 inches deep, and the total weight of the instrument is 6 pounds.

Maker—Radio Products Co., Dayton, Ohio.

A Handy Tool for the Serviceman

Description—The "Handihold" tool is a convenient instrument for the radio serviceman or experimenter as well as the mechanic. Only one hand is required for its operation, and it is especially adapted for use in con-

lined places where the fingers or another tool cannot reach. The plunger and coil-spring arrangement forces the four fingers of the instrument outwards to grip the screw, nut or other form of hardware applicable to

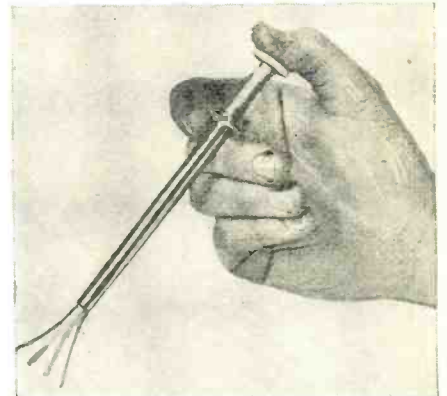

the work at hand. When the plunger is fully depressed, the gripping fingers can extend outward 1 1/2 inches. The spring on the handle has a tension of 11 pounds. There are three sizes available. The short size illustrated here measures 6 3/4 inches long by 5/16 inch in diameter.

Maker—Lundberg Mfg. Co., 3508 Grand River Avenue, Detroit, Mich.

A Portable Radio Receiver

Description—This new portable receiver, model A-81, with the new type of twin-push amplification requiring a light drain on the B batteries, features automatic volume control and a permanent magnet type loudspeaker. The receiver is especially adaptable for camps, picnics, auto and power-boat installations or the many occasions where a portable set is desired. The receiver chassis and reproducer are enclosed in a conventional style traveling case, covered with leatherette. The dimensions of this case are



14 1/2 inches high by 21 3/4 inches wide by 9 5/8 inches deep, and the complete equipment, with batteries, weighs less than fifty pounds. The set utilizes the following tubes: four -30 type, one -32 type and three -34 type.

Maker—General Electric Co., Bridgeport, Conn.

Pocket Diagnometer

(Continued from page 305)

for attention concern the method of mounting the C battery clip and the rheostat R1. This clip can be made of any springy metal. It is mounted by slotting one end and slipping this end under the meter shunt spool after loosening the single screw which holds this spool in position. The rheostat is mounted on the end of the case which encloses the entire unit. If this case is of metal, the rheostat should be insulated from it.

After the assembly and wiring are completed, the unit should be tested in all its ranges. The current ranges can be tested with a flashlight cell in series with a 2000-ohm external rheostat. The voltage ranges can be tested with B batteries, line voltage or other sources of adequately high voltage. The resistance-measuring circuits are tested by first short-circuiting the binding posts T2 and T3, with SW2 set on the 1 ma. range and SW3 set on the "OHM" position. Adjust rheostat R1 to give full-scale meter deflection. Then connect resistors of known value across binding posts T2 and T3 in place of the short-circuiting wire. The values of these resistors can then be read directly on the top scale of the meter. Should the meter read backwards, simply reverse the polarity of the C battery.

To completely understand the functioning of each part of the meter, it is suggested that the reader trace through one circuit after another. To make this more simple, it may be well to explain that for resistance measurements in the 100,000-ohm range (1 ma.), resistor R2 is in series with resistor R1, but for the lower resistance ranges R2 is automatically cut out of the circuit. It will likewise be noted that there is no multiplier resistor in the circuit when switches are set for the 5-volt a.c. range. Such a multiplier is made unnecessary by the fact that the meter itself offers a resistance of 5000 ohms in this range. In the 5-volt d.c. range, on the other hand, the multiplier resistor R11, which has a value of 4950 ohms, plus the 50-ohm resistance of the a.c. portion of the meter, provide the necessary total of 5000 ohms required for this range.

No specifications are given in this article for a case for this instrument. The reason for this is that most readers who construct the unit will have their own ideas concerning its housing. Many will wish to install it in a kit bag, or to include it in a case sufficiently large to provide space for spare tubes, replacement parts, etc.

List of Parts

- M—Weston model 301, a.c.-d.c. universal meter
- R1—Yaxley wire-wound variable resistance, 1000 ohms
- R2—Van precision resistor, 4000 ohms
- R3, R4, R5, R6—Van precision meter multiplier resistors, 5000 ohms, 45,000 ohms, 245,000 ohms and 1 megohm respectively
- R7, R8, R9, R10—Van meter shunts, 10 ma., 5 ma., 25 ma. and 100 ma. respectively.
- R11—Van precision meter multiplier, 4950 ohms
- SW1—Cutler-Hammer polarity-reversing switch
- SW2—Best type 3NS10 tri-polar 10-point switch
- SW3—Best type 3NS3 tri-polar 3-point switch
- SW4—Push-button switch, single pole
- T1, T2, T3—Air Research universal type binding posts
- 1 Van four-range calibrated meter dial
- 1 Van panel, cut, drilled and engraved
- 1 Burgess type 5360 C battery, 4½ volts
- Wire, solder, lugs, etc.

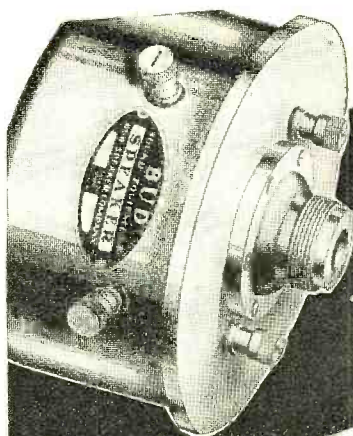

*Dependable
Sensational
Performance!*

... BUD Loud Speakers

Mr. C. M. Fox, Technical Engineer

First in the speaker field because of their POSITIVE DEPENDABILITY and SENSATIONAL PERFORMANCE... a performance unequaled by any dynamic speaker today. BUD has a guaranteed operating capacity of 25 WATTS and a peak load of 50 WATTS! It assures you against embarrassing, inconvenient, costly breakdowns! That's why the world's largest sound truck is equipped with BUD LOUD SPEAKERS and BUD ALL-ALUMINUM TRUMPETS!

**5 DAYS
FREE
Trial**

Test BUD SPEAKERS with this amazing FREE trial plan.

Discard your obsolete, inefficient, costly, troublesome units. Standardize on BUD! It costs less to enjoy a BUD than to be annoyed with an ordinary speaker! Let BUD's Sensational Performance convince you of BUD's Positive Dependability. Send the coupon today!

BUD SPEAKER CO.
1158 DORR ST.
TOLEDO, OHIO-U.S.A.

FREE 5-Day Trial Coupon

BUD SPEAKER COMPANY,
1158 Dorr Street,
Toledo, Ohio

Send me more facts about your Five-Day FREE TRIAL on BUD Speakers and BUD all-aluminum Trumpets.

Name.....
Street Address.....
City..... State.....



THE WORLD'S LARGEST RADIO SELECTION

brought to your home!

The new 1933 WHOLESALE RADIO SERVICE COMPANY Catalog is now ready—just off the press. The latest, greatest edition of radio's bargain book. Featuring the newest developments—1933 LAFAYETTE RECEIVERS, TRUSTEES PARTS, tubes, speakers, kits, accessories, short wave sets and apparatus, amplifiers, public address systems, REPLACEMENT PARTS, etc. Everything brand new—at the lowest WHOLESALE prices in all our history.

RADIO SERVICE MEN!

Wholesale Radio carries a tremendous stock of REPLACEMENT PARTS for all sets. What you need when you want it—at WHOLESALE PRICES. Buy with confidence and safety from the largest institution of its kind in the world.

Write for a FREE copy of our new 1933 Catalog Today, and bring the world's largest radio selection to your home. No obligation—just mail the coupon!

Wholesale Radio Service Co., Inc.
100 Sixth Ave. Dept. L-12
New York, N. Y.

Please send copy of your new 1933 Radio Catalog.

Name.....
Address.....
City..... State.....

MAIL COUPON NOW FOR
FREE CATALOG!
Wholesale Radio Service Co. Inc.
100 Sixth Ave. Dept. L-12 New York

Just Published!
New 4th Edition
Nilson and Hornung's
RADIO OPERATING
QUESTIONS AND
ANSWERS

350 pages, 5½ x 8, 96 Illustrations, \$2.50

GIVES over 600 questions and answers covering all radio operator license examinations. Will help you pass examinations and to know your stuff better in any field of practical radio. New edition brought completely up-to-date with many new questions and information on:

Broadcasting, marine, aeronautical, police, amateur operating—latest types of transmitters and other equipment—unlimited amateur telephone operator's license—new radio laws—regulations governing issuance of all classes of radio operator's license examinations—etc.

Every question is typical of those on examinations; answers are complete, illustrated, give information essential to meet any situation. For amateurs, short-wave fans, men preparing for operator examinations or technical positions. Radio companies give preference to licensed operators for all positions. This book gives quick, direct preparation for all examinations.



See it 10 days free
 Send this coupon

McGraw-Hill Book Co., Inc.,
 330 W. 42nd St., N. Y. C.

Send me Nilson and Hornung's Radio Operating Questions and Answers, postpaid, for 10 days' free examination. I will send \$2.50 or return the book within 10 days of receipt.

Name.....
 Address.....
 City and State.....
 Position.....
 Company..... RN-11-32
 (Books sent for free examination to retail purchasers in U. S. and Canada only.)

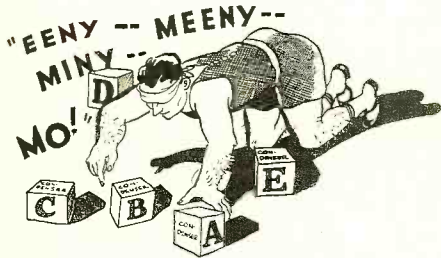

"EENY, MEENY, MINY MO!"—How meaningless, this formula for the simple selections of childhood, yet how frequently is as meaningless a method of selection employed when grown-ups choose variable condensers!

Chance may favor you in some of your "Eeny, Meeny, Miny Mo!" selections, but chance should have no part in your choice of this most important part of your receiver or transmitter. Why experiment with anything whose superiority has yet to be proved? If results really mean something to you, hook up to CARDWELLS and see how they'll stick by you and hold down the job.

CARDWELL receiving condensers, and CARDWELL transmitting condensers for broadcasting, commercial and Amateur stations, for aircraft installations and portable sets, have won—and kept—the confidence of engineers and Amateurs the world over.

Send for Literature

THE ALLEN D. CARDWELL MFG. CORP.
 89 Prospect St., Brooklyn, New York

"THE STANDARD OF COMPARISON"

RADIO'S REWARDS



are rich for those who are prepared. Study all branches of practical radio at RCA Institutes, America's oldest radio school. Resident schools in New York and Chicago. Also extension courses for home study on new "no obligation" enrollment plan. Catalogue upon request.

RCA INSTITUTES, Inc.
 Home Office, Dept. RN-111
 75 Varick St. New York

Everything on the Air

(Continued from page 277)

connect to coils which are coupled to the antenna circuit. In this way the second r.f. amplifier tube becomes the first on the short waves.

The coupling between the second r.f. tube and the detector is of the impedance type which makes switching in the plate circuit unnecessary. The fifth section of the switch

The shaft consists of a metal rod in the center with a hard-rubber tube over it. In this tube is a groove, running lengthwise, which serves to take the set-screws of the variable contact arms (B). Contact to the variable arms is provided by a copper runner (C), which is clamped between the contact arm and the insulating plate. The

THE RECEIVER IN ITS SHIELD

Although inter-stage shielding is almost totally lacking, a high degree of stability is demonstrated, together with excellent sensitivity and low noise

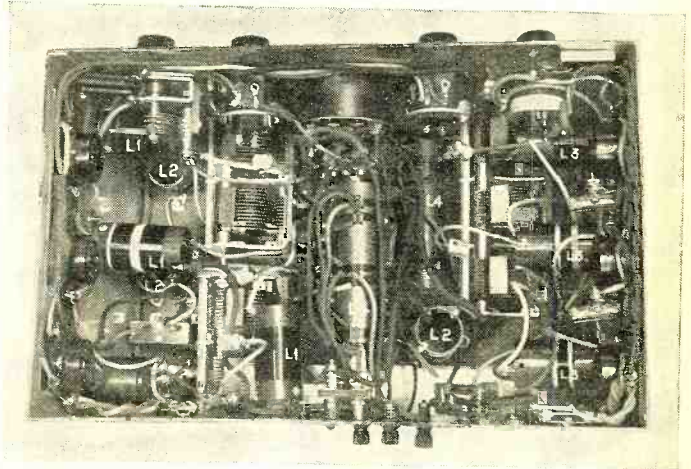

takes care of the tuned circuit for the detector. The tickler is controlled by the last section. Since there is no tickler for the broadcast band, the first contact stud connects to the plate-coupling resistor through the radio-frequency choke.

For more effective tuning on the short waves, a series condenser is inserted in the antenna circuit. It is used in three wave bands and therefore must be placed in the common ground lead of the three short-wave antenna primaries.

The volume is controlled by a variable bias resistor in the cathode lead of both of the radio-frequency amplifier tubes. The off-and-on switch for the receiver is mounted on this volume control.

Regeneration is controlled by varying the screen-grid voltage on all three of the screen-grid tubes. A potentiometer of 50,000 ohms is connected across a part of the voltage divider and the screens are connected to the variable arm.

Now we come to the television receiver. It is entirely separate from the sound receiver and it has its own power supply. The diagram is shown in Figure 2.

This receiver does not employ variable-mu tubes; the volume is controlled by varying the screen voltage by means of a 50,000-ohm potentiometer. The off-and-on switch is again mounted on the volume control.

The output stage consists of two -45 tubes in parallel to drive the neon light in the Jenkins television.

Since the wave band from 90-130 meters has not been covered by the sound receiver, the television set is expected to take care of that. For the reception of police signals, for instance, the television set can be turned on and the speaker substituted for the television lamp. There is a switch on the television for the purpose.

The reader has by now understood that the switch consists of several variable arms moving over contact studs, all arms being moved by a single shaft. Drawings of parts of the switch are shown in Figure 3. A number of insulating plates like plate A are mounted on two rods and kept at the right distance by means of spacers. The photograph makes this clear. Through the center of the plates the shaft runs, resting in bearings at both ends of the mounting.

lower part of this ring is fastened to the single contact stud on the lower half of the plate.

It goes without saying that the number of contact studs on the plates might have been arranged differently or that the mechanical placement of the supports could be such that the movable arm could make a complete turn instead of only half a turn, as in the illustration.

In one of Mr. Whisk's receivers there were more plates carrying contacts so that signal lights could be connected automatically by the switch, indicating to which waveband the receiver was set. The turning off and on of the power can also be done with the same switch, but then it takes one more section.

Coils are a problem for many experimenters. In order to aid the home builder, the specifications for the coils in this receiver are given here. All coils are wound on a bakelite form of 1¼-inch diameter and

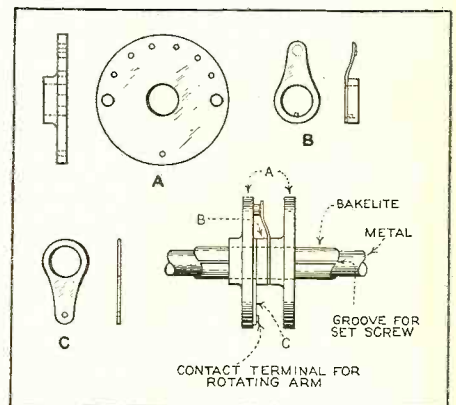

MULTIPLE-SWITCH DETAILS

Figure 3. The details of switch construction are given in the text. These drawings show some of the parts

with enameled wire. On some coils the primary is wound over the secondary, but usually at one end, with about ⅓-inch space between them.

200-700 Meter Band—The tuned second-

daries consist of 150 turns of Number 30 enameled wire. The antenna-coupling coil consists of 10 turns, the band-pass circuit of 145 turns with an 8-turn primary in series with it. The primaries of the interstage transformer consist of 55 turns.

130-360 Meter Band—The antenna coupler has 8 turns, the tuned secondaries 60 turns, and the interstage primary of 25 turns is wound over the secondary. Number 30 wire is used.

90-200 Meters—These coils are for the television receiver. The secondaries consist of 30 turns each, the antenna-coupling coil of 18 turns and the interstage primary of 25 turns are wound over the secondaries. Number 28 silk-covered wire is used.

40-90 Meters—Primaries, secondaries and ticklers all consist of 10 turns of Number 28 enameled wire.

30-45 Meters—Antenna primary and tuned circuits, 6 turns; the tickler has 8 turns. Number 28 enameled wire is used.

20-30 Meters—Antenna primary and tuned circuits, 4 turns of Number 18 enameled wire. The tickler is closely wound with 6 turns of Number 28 enameled wire.

12-20 Meters—The antenna coupler consists of 3 turns of Number 18 enameled wire; the secondaries of 3 turns, spaced 3/16 inch apart, of Number 12 enameled wire. The tickler consists of 6 turns of Number 26 enameled wire, close wound.

To the surprise of the author, the coils were not shielded from each other; yet the set was stable. In the photograph of the radio-frequency tuner their positions can be seen.

Some of the coils are deeper down and at right angles to the others. The coils for the 49-90 meter band can be seen clearly. All of them are wound on one form. For the broadcast band there are four different coils, placed on the left side. (On the photograph these have been marked L1.) The fourth one is lower down and cannot be seen. The coils for the 130-360 meter band

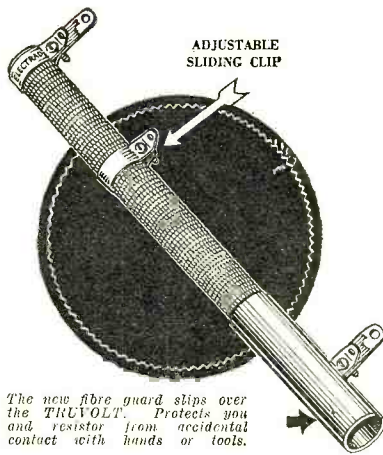

The new fibre guard slips over the TRUVOLT. Protects you and resistor from accidental contact with hands or tools.

MERVE!

for Greater CONVENIENCE

TRUVOLT Resistors offer several exclusive advantages:

- 1—Patented construction permits larger wire, giving longer life and greater heat radiation.
- 2—TRUVOLT construction gives better electrical contact.
- 3—TRUVOLT spiral winding of the resistance wire provides finer adjustment.
- 4—Adjustable sliding clips may be added, removed or set for any desired voltages.
- 5—Every TRUVOLT Resistor has a full-length fibre guard. Prevents injury from accidental contact with tools.
- 6—Because of these exclusive features, TRUVOLTS are the most economical and adaptable of all resistors.

STANDARD VOLUME CONTROLS

Instantly Changed to Use Power-Switch

All ELECTRAD STANDARD VOLUME CONTROLS are now instantly convertible to use a power-switch, merely by removing the end cover and snapping the cover, with switch attached, in its place. All ELECTRAD STANDARD VOLUME CONTROLS are now equipped with long aluminum shafts—Easy to cut to any desired length—less time; less trouble.

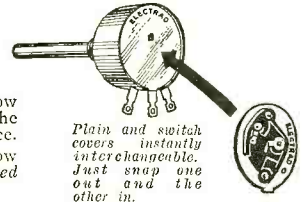

Plain and switch covers instantly interchangeable. Just swap one out and the other in.

RESISTOR REPLACEMENT HAND BOOK

The most valuable resistor replacement guide ever compiled for service men and experimenters. Accurate, loose-leaf information on resistor values for all receivers. Kept up-to-date by four supplements a year. Sold on a 10-day trial, money-back guarantee.



\$1.00 a year with 4 supplements.

Write Dept. RN-11 for New Catalog.

175 Varick St. New York, N.Y.
ELECTRAD
INC.

A COMPLETE P. A. SYSTEM FOR \$47

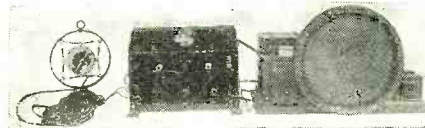

Just what you have been waiting for; a complete public address system under \$50.00. Everything from microphone to amplifier and tubes. All that is required is about two hours work assembling

and wiring microphone-phonograph pre-amplifier and mixer and the outfit is ready for use. Make money renting this system for political speeches, fairs, church bazaars and theatre ballyhoo. Your original cost can be made in two or three days work. Complete, as listed below, for \$47.00. Parts can also be purchased separately.

Qty.	Description	Price	Qty.	Description	Price
1	Kolster K-5 Amplifier	\$5.95	2	2,000 ohm 1 watt pigtail resistors	\$.26
1	R. C. A. 210 Tubes	4.12	1	50,000 ohm potentiometer	.55
2	R. C. A. 281 Tubes	5.88	1	400 ohm potentiometer with switch	.75
2	R. C. A. 227 Tubes	1.20	1	G. R. Audio Transformer	1.20
1	874 Voltage Regulator Adapter	.20	1	American Microphone Transformer	2.50
1	Mixer—Amplifier Cabinet	3.75	1	2 1/2 Volt Filament Transformer	1.10
1	Mixer—panel (drilled and engraved)	1.85	2	Base Mount—UY Sockets	.32
3	Phone Jacks	.30	2	1 mfd. 200 volt by-pass condensers	.70
1	Barrel Phone Plug	.39			
6	Marked Binding Posts	.42			
2	Tip Jacks	.15			

Write for new Wholesale Radio Catalog just off the press.

AMERICAN SALES CO. 44 West 18th St. New York, N. Y.

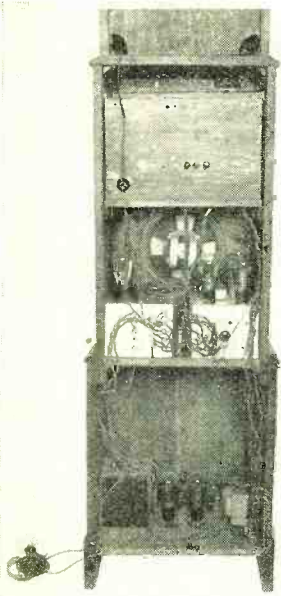

THE REAR VIEW

Partly cut off at the top is a clock. Below that, in order, are the receiver, loudspeaker, amplifiers (television and voice) and separate power supplies for the television and voice sections

are standing up vertically in the photograph. They have been marked L2. The coils for the television band, L3, can be seen on the right side of the photograph. The right half of the box is nearly completely occupied by the television tuner. L4, the 49-90 meter coils, can be seen in the foreground. The

Quickly and easily attached to any aerial.

NOISELESS RADIO RECEPTION

Cut out the clicks and crashes of "man-made static," spoiling your pleasure. Get the best results from your Radio, at small cost.

—:— The NEW "AKAFORMER" —:—

A revelation to novice and expert—a major contribution to the Radio industry and solves your problem. TRY IT!

Clip this adv. and enclose \$2.50 for special offer.

Special Offer to DEALERS: SERVICE-MEN:

For \$2.50 we will ship postpaid one "AKAFORMER" and 75 feet of approved tested, shielded cable, on a trial basis. (West of Miss. River 15c postage extra); or sent C.O.D. plus charges.

Money back guarantee. Write for folder.

Consulting Engineers

AMY, ACEVES & KING, Inc., 11 West 42nd Street, New York



... yep
I'm master of my radio"

And listen, if your radio set goes temperamental on you, get busy with Kester Radio Solder. Be master in your own home. Kester Radio Solder has a plastic rosin flux—non-corrosive and a non-conductor—it is the only kind that doesn't spoil on the dealers' shelves. It keeps out dust and moisture, prevents electrical leakage—and thus aids receptivity. You can hear the difference.

Kester is the easiest thing in the world to use. Flux inside the solder itself—nothing for you to do but apply heat. Nobody could go wrong with Kester Radio Solder. Why don't you write Kester for "The ABC of Soldering?" It's free. And buy a handy can of Radio Solder now, at almost any good store nearby. Be sure and ask for Kester.

Kester Solder Company, 4201-13 Wrightwood Ave., Chicago, Ill. Eastern Plant, Newark, N. J. Canada, Kester Solder Company of Canada, Ltd., Brantford.

KESTER

RADIO SOLDER

easy to use

FREE RADIO ACCESSORY CATALOG AND PUBLIC ADDRESS AMPLIFIER SYSTEMS CREATES

Write for this Book to-day!
YOU CANNOT POSSIBLY AFFORD TO BE WITHOUT THIS VALUABLE BOOK.

It is an up-to-date ENCYCLOPEDIA of the RADIO INDUSTRY

WHOLESALE PRICES!

OUR CATALOG LISTS EVERYTHING YOU CAN BUY—100 WATT TUBULAR PANEL P.A. AMPLIFIER!

We are manufacturers of CLASS A AND B PUBLIC ADDRESS AMPLIFIERS Producing Undistorted Outputs Ranging from 4 to 100 Watts. Get our Quotations on Complete Single and Dual Channel Sound Truck and Semi Stationary - A. In installations... BUY DIRECT FROM THE MANUFACTURER AND SAVE BIG MONEY!

COAST-TO-COAST
RADIO CORPORATION

123 N West 17th St., New York N.Y.

WE WANT..

EXPERIENCED RADIO MEN who want MORE MONEY! Our advanced course in RADIO and TELEVISION ENGINEERING is your "short cut" to success—this course is not for beginners, we want to help you Radio men who want to get ahead.

Write today, for our free booklet, explaining the advanced course in Radio and Television Engineering.

CAPITOL RADIO ENGINEERING INSTITUTE
14th and Park Rd., N. W., Washington, D. C. Dept. RN-11

short-wave coil, L5, covers the 30-45 meter band. Other coils are not visible in the photograph.

The power packs for the two receivers are of the conventional type and are mounted at the bottom of the cabinet. The filters and the audio amplifiers are on the next shelf. The sound amplifier is at the left and the television amplifier at the right.

Now as to the results obtained with this combination. At a demonstration in Brooklyn (not a very good location), England, Spain and Germany were tuned in without much difficulty. The speech was accompanied by the usual "transatlantic" noise, but it was clearly understandable and less noisy, in fact, than some commercial receivers.

Television, sight and sound at short waves, was tuned in by simply turning on the second receiver and the scanning motor. Broadcast reception with excellent quality was brought in immediately afterwards.

The long waves could be covered very well, if desired, by substituting other coils for some of the present ones or by using a switch with more positions.

For the experimenter who is interested in covering all wavelengths, the ideas included in Mr. Whisk's equipment, as described here, should prove suggestive and helpful.

5-Meter Measurements

(Continued from page 285)

bare], each 25 feet long, separated from 6 to 8 inches, and coupled to the oscillator (the 56-megacycle transmitter) by means of about two turns of wire, 2 inches in diameter, at the closed end. The easiest way of making such a system is to take 51 feet of wire, wind the two turns in the middle, and stretch the wires in a convenient direction. The proximity of walls apparently has little effect on the accuracy of the measurements, and stand-off insulators can be used. The required length of the wires can be shortened somewhat by shunting a small condenser—5 to 10 mmfd.—across the two turns. This tends to bring the first point of

Radio News Technical Information Service

The Technical Information Service has been carried on for many years by the technical staff of RADIO NEWS. Its primary purpose is to give helpful information to those readers who run across technical problems in their work or hobby which they are not able to solve without assistance. The service has grown to such large proportions that it is now advisable to outline and regulate activities so that information desired may come to our readers accurately, adequately and promptly.

Long, rambling letters containing requests that are vague or on a subject that is unanswerable, take up so large a portion of the staff's working time that legitimate questions may pile up in such quantities as to cause a delay that seriously hinders the promptness of reply. To eliminate this waste of time and the period of waiting, that sometimes occurs to our readers as a consequence, the following list of simple rules must be observed in making requests for information. Readers will help themselves by abiding by these rules.

Preparation of Requests

1. Limit each request for information to a single subject.
2. In a request for information, include any data that will aid us in assisting in answering. If the request relates to apparatus described in RADIO NEWS, state the issue, page number, title of article and the name of the device or apparatus.
3. Write only on one side of your paper.
4. Pin the coupon to your request.

The service is directed specifically at the problems of the radio serviceman, engineer, mechanic, experimenter, set builder, student and amateur, but is open to all classes of readers as well.

All questions from subscribers to RADIO NEWS will be answered free of charge, provided they comply with the regulations here set forth. All questions will be answered by mail and not through the editorial columns of the magazine, or by telephone. When possible, requests for information will be answered by referring to articles in past issues of

the magazine that contain the desired information. For this reason it is advisable to keep RADIO NEWS as a radio reference.

Complete information about sets described in other publications cannot be given, although readers will be referred to other sources of information whenever possible. The staff cannot undertake to design special circuits, receivers, equipment or installations. The staff cannot service receivers or test any radio apparatus. Wiring diagrams of commercial receivers cannot be supplied, but where we have published them in RADIO NEWS, a reference will be given to past issues. Comparisons between various kinds of receivers or manufactured apparatus cannot be made.

Only those requests will be given consideration that are accompanied by the current month's coupon below, accurately filled out.

NOVEMBER, 1932

Technical Information Coupon
RADIO NEWS Laboratory
222 W. 39th Street
New York, N. Y.

Gentlemen:

Kindly supply me with complete information on the attached question:

- I am a regular subscriber to RADIO NEWS, and I understand this information will be sent me free of charge.
- I am not yet a subscriber to RADIO NEWS.
- I wish to become a subscriber to RADIO NEWS, and enclose \$2.50 to receive the magazine regularly for one year, and to receive this valuable technical information service free of charge.

Name.....

Address.....

TOBE FILTERIZERS laugh at your worst enemy MAN-MADE S.T.A.T.I.C



HERE it is! The "something to put on the radio set" that you have been looking for ever since the first crash of man-made static spoiled a radio program for you.

THE Tobe Filterizer Kit keeps radio noise out of the receiver by the simple method of filtering the power input to the set, providing an aerial outside the field of radio noise, and carrying broadcast signals to the receiver through a FILTERIZED lead-in system.

TO ANY radio receiver—anywhere—add the Tobe Filterizer. The result—relief from man-made static.

TRY it today and see for yourself the remarkable freedom from radio noise that results from the use of this kit.



The Tobe Filterizer Kit includes

- 1—Antenna Filterette RF-1 Complete
 - 1—Line Filterette RF-2
 - 1—Filterized Shielded Lead-in RF-3
- \$9.75**

FILL OUT—MAIL TODAY

Please send me full information concerning the Tobe Filterizer and where I can buy it.

Name

Street

City

State

TOBE DEUTSCHMANN CORP.

Filterette Division

CANTON, MASSACHUSETTS

The Acknowledged Authority on Radio Interference—Makers of FILTERETTES, the Accepted Remedy

measurement closer to the input, but does not change the distance between the first and second points, which is what we are after. (Do not measure between the input end and the first point.)

There are four possible Lecher wire methods, recommended to the amateur in varying degrees of convenience, and which are shown in Figure 4. The variations are in the nature of the movable bridge. In A, the bridge is a length of heavy copper wire which short-circuits the Lecher wires. It is moved along the wires until points 1 and 2 are discovered which give the maximum dip on a grid meter in the oscillator. The wavelength is twice the distance between points 1 and 2.

In system B, the bridge consists of a microammeter which is moved along the wire, indicating maximum current at current anti-nodes—again spaced one-half wavelength apart.

In C, the bridge is again a short-circuiting wire and maximum current readings are taken from the microammeter, in series with the two-turn pick-up coil.

In system D a sensitive neon lamp is moved along the wires to locate two voltage maxima one-half wavelength apart.

The Lecher wire system should always be coupled as loosely as possible to the transmitter, while still allowing sufficient coupling for the accurate determination of the nodal or anti-nodal point.

Regardless of which system is used, the general procedure is the same. The signal is picked up on the frequency meter, the dial reading and wavelength noted, and the latter converted into frequency if desired. Additional measurements are made with different settings on the transmitter, Lecher wire and frequency meter, until sufficient points are secured to plot a curve, which is corrected, as before explained, by reference to an accurate "spect" frequency.

Absorption Meters

The absorption type meter can be used for quick and approximate frequency determinations. In general, the same sources of error which make this type of measurement undesirable for lower frequencies are much more insidious in ultra-high-frequency work. A large error will result if, for instance, the experimenter attempts to absorb enough energy to light a series lamp from a low-power, 5-meter oscillator. If, however, the wavemeter is used in conjunction with a highly sensitive thermo-galvanometer as an indicating device, it will give fair results on transmitter measurements. Similar reliability can be placed on loosely coupled absorption measurements when a grid meter in the transmitter circuit is used for resonance indication.

Photograph, Figure 5, provides constructional data on a simple absorption type meter. The coil is wound with two turns of number 12 wire with a diameter of about 1½ inches, spaced ½ inch. The condenser has a maximum capacity of 12 mmfd. The wavemeter is mounted on an R-39 coil form which is used as a convenient handle.

The absorption type meter is calibrated in exactly the same manner as described for the oscillating frequency meter.

Lab-Built Super

(Continued from page 287)

was first made on the European short-wave stations. The reception results, in spite of the city location, were every bit as good as at Fairfield, and in some cases much better. G5SW, Chelmsford, for instance, came in with volume enough to be heard 75 to 100 feet from the speaker, and an interested witness of these tests remarked on the fidelity of re-

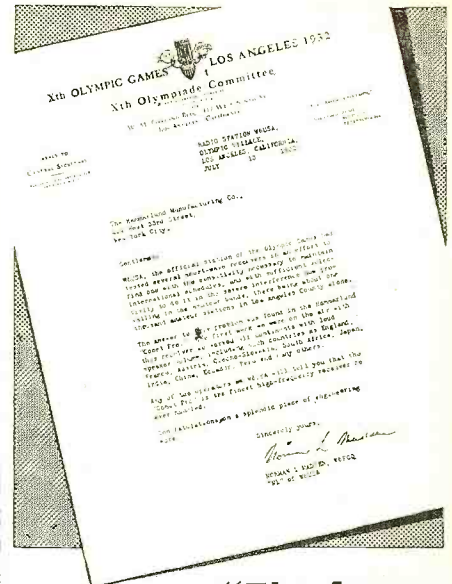

"The Answer: COMET 'PRO'"

"We tested several short-wave receivers to find one with the sensitivity to maintain international schedules, and sufficient selectivity for the severe interference now prevailing, there being about 1,000 amateur stations in Los Angeles County alone. The answer was the "Comet Pro." We work all continents with loudspeaker volume, including England, France, Austria, Czechoslovakia, South Africa, Japan, India, China, Ecuador, Peru and many others. Any operator at W6USA will tell you that the "Comet Pro" is the finest high-frequency receiver he ever handled. Congratulations on a splendid piece of engineering."

NORMAN L. MADSEN,
Operator, W6USA,
Official Station of the Olympic Games.

Due to recent tube developments, the new model "PRO" is even more selective. Delivers full loudspeaker volume. Increased intermediate amplification, with greater stability. Smooth operation on 10 to 20 megacycle band. More effective shielding. New metal cabinet removes all stray influences. Wood cabinet optional. A really GREAT receiver!

Mail
Coupon
for
16-page
Folder

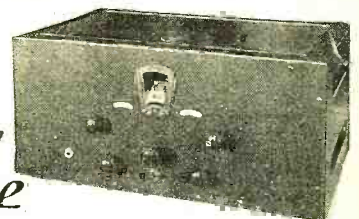

The

COMET

Custom-Built "PRO"

by
HAMMARLUND

HAMMARLUND-ROBERTS, INC.,
424 W. 33rd St., New York

Please send me 16-page illustrated folder, describing the COMET "PRO" Short-Wave Superheterodyne.

Name

.....

.....

..... RN-11

TRANSFORMERS

KENYON

QUALITY - RELIABILITY



KENYON Laboratory Standard Audio Components are an outstanding contribution to the development of flat line amplifier equipment.

A frequency response characteristic of plus or minus 1 DB over the entire audio broadcast spectrum for standard ratio coupling, input, output, and line matching transformers—encasing all radio, power and filter components in high permeability cast iron shields to prevent the possibility of induced hum or of parasitic oscillations, these are factors which have won over the leading audio research laboratories, broadcast stations, university research bureaus, experimenters, inventors, and exacting amplifier engineers to the use of Kenyon audio equipment.

Kenyon Laboratory Standard Audio Transformers, when used in transmitting or receiving sets designed to amplify the audio spectrum fully and uniformly, are so close an approach to life-like reproduction as to put the burden of further improvement in amplifier reception on the inventive genius of microphone and speaker specialists.

Kenyon All Purpose Amplifier Components, the KR series of Universal replacement power transformers and the Manufacturers' type Audio Components have won high favor amongst leading set manufacturers and enterprising servicemen.

The complete kit of Laboratory Standard Audio Components on the Kenyon 845-50 Watt Power Amplifier is available through key jobbers in the principal radio centers in the United States, Canada, Mexico, South America and Continental Europe.

Laboratory schematic diagrams and layouts for 845-50 Watt, 250, 245, triple twin and Class B power amplifiers are now ready for distribution. Write for yours. Free for the asking.

Kenyon Transformer Co., Inc.
122 Cypress Ave., New York, N. Y.

This low priced, Class "A", Public Address Amplifier is solely on display and being demonstrated at the American Sales Company. Drop in and hear this wonderful sounding Amplifier at their show rooms located at 44 West 18th Street (between 5th and 6th Ave.), New York City.

F. & H. CAPACITY AERIAL



Price \$1.00 Complete postpaid

Every Instrument Tested on Actual 1127 Mile Reception
A LARGE NUMBER ARE IN USE BY GOVERNMENT, IN NAVY HOSPITAL

The F. & H. Capacity Aerial Eliminator has the capacity of the average 75-foot aerial, 50 feet high. It increases selectivity and full reception on both local and long distance stations; is absolutely guaranteed. It eliminates the outdoor aerial along with the unsightly poles, guy wires, mutilation of woodwork, lightning hazards, etc. It does not connect to the light socket and requires no current for operation. Installed by anyone in a minute's time and is fully concealed within the set. Enables the radio to be moved into different rooms, or houses, as easily as a piece of furniture.

Dealers! Order sample, write for proposition.
Notice: This instrument is for sale at all S. S. Kresge Dollar Stores, Gamble Stores, Neisner Bros. Stores or you may order direct.

SEND COUPON, IT PROTECTS YOU

Name.....
Address.....
City.....State.....

Send one F. & H. Capacity Aerial with privilege of returning after 3-day trial if not satisfactory, for which enclosed find check M. O. or dollar bill, or send C. O. D. Send Literature. Dealer's proposition.

F. & H. RADIO LABORATORIES
Fargo, N. Dak. Dept. 19

ception of this short-wave English station. For the five consecutive evenings when the set was hooked up in New York City, F.Y.A. France (with the Marsellaise), and G5SW, England (with the chimes of Big Ben), were heard signing off. During this period the European reception was consistently satisfactory.

Daytime reception in New York City brought in WIP, Philadelphia; WGY, Schenectady; WICC, Bridgeport, in addition to a multitude of closer stations, all with good loudspeaker volume and a favorable noise-signal ratio.

The evening operating tests for the broadcast band measured up to the tests in Fairfield. The location for the city test is close to a number of high-powered local stations, but no difficulty was encountered in tuning in distant stations on channels immediately above and below these locals.

The apartment-house antenna is a single wire of 40 feet with a lead-in of 20 feet, and a ground connection measuring 10 feet to the cold-water pipes.

From the foregoing reports it is evident that the CB-1 receiver functioned consistently throughout the three sets of tests. The only possible exception was found in the daytime short-wave reception tests at Fairfield, but it is believed that the inability to obtain really good results was due to the poor short-wave transmission conditions existing at that time rather than in any inconsistency in the receiver itself. This belief is borne out by the fact that EAQ of Madrid was very satisfactorily received the preceding evening.

Evidently the receiver not only provides a high degree of sensitivity on both the broadcast and the shorter waves, but also a degree of selectivity adequate to meet any normal city or suburban requirements. A receiver which will provide real 10 kc. selectivity when operating within the New York City limits should provide entirely satisfactory reception so far as selectivity is concerned under almost any condition that can be imagined.

As mentioned in the Chicago report, the tone quality was found to be entirely satisfactory and the output volume was surprisingly high for a pair of -45's. This high volume is accounted for by the true Class A audio amplifier design which enables the -45 tubes to provide an undistorted output of approximately 8 watts. This relatively high output is then fed into the new speaker having an unusually high conversion efficiency.

P. A. System

(Continued from page 283)

the plate and cathode of any stage. This meter should have a range of 0-300 volts. The voltage of each stage can thus be adjusted accurately with the rheostats.

Plate current can be measured with a milliammeter mounted on panel 1. Three push-button switches enable the operator to connect the meter in any one of the three cathode leads (see Figure 1).

List of Parts (Panel No. 1)

- C1, C4—Aerovox 1 mfd. condensers, 200 volts
- C2, C5—Aerovox 1 mfd. condensers, 400 volts
- C3, C6—Aerovox ¼ mfd. bakelite case condensers, 400 volts
- L1, L2—Kenyon parallel-feed chokes, type KC-300-3
- M1—Milliammeter, 0-25 ma. range
- R1, R3, R5—Aerovox 50,000-ohm, 1-watt metallized resistors
- R2, R4—Aerovox 2700-ohm, 2-watt metallized resistors
- R6—Aerovox 1350-ohm, 10-watt vitreous-enameled resistor

- S1—Federal double-pole-double-throw switch
- S2, S3, S4—Yaxley push-button switches, type 2007
- T1—Kenyon audio transformer, type KALG
- T2—Kenyon transformer, type KADL
- T3—Kenyon audio transformer, type KALG
- T4—Kenyon audio transformer, type KA-12
- T5—Kenyon audio transformer, type KA2DL
- VC—Centralab 500-ohm T-pad
- 4 subpanel sockets, 5-prong
- 1 subpanel
- 6 Eby binding posts
- 1 cable receptacle, 7-prong

List of Parts (Panel No. 2)

- C7, C8, C9—Aerovox electrolytic condenser block E5-2816
- C10, C11, C12—Aerovox 2 mfd. condenser, 400 volts
- L3—Kenyon filter choke, type KC-15-120
- L4—Kenyon filter choke, type KC-40-60
- L5, L6, L7—Kenyon filter choke, type KC-700-5
- M2—Voltmeter, 300-volt range
- R7, R8—Ward-Leonard adjustats, 50,000 ohms
- R9—Ward-Leonard adjustats, 25,000 ohms
- R10—Aerovox bleeder resistor, 5000 ohms, 25 watts
- S5, S6, S7—Yaxley push-button switches, type 2003
- T6—Kenyon power transformer, type K-245-PT
- 1 subpanel type 4-prong socket
- 1 battery cable receptacle, 7-prong
- 1 a.c. receptacle

For Interconnection Between Panels

- 1 and 2
- 1 battery cable, 7-wire
- 2 cable plugs, 7-hole type

Television and Sound

(Continued from page 271)

detector with a tuning circuit set to 45 kilocycles to obtain the audio signal.

When the writer discussed the plan with Lodge at the inception of the new system, the engineer declared that listeners could also utilize two separate receivers for the sight-and-sound portions of the transmissions. He declared that some television receivers on the market did not provide for a sufficiently high-frequency audio response for good reception. However, if the television receiver is satisfactory in this respect, he said, the necessary alterations for the sight-and-sound reception would cost but a few dollars.

The launching of the new system coincided with the first anniversary of the network's entrance into the television field and a special program for the event was arranged. Schudt and Cohan spoke on the engineering aspects of the initial year's television operation and the prospects for the year to come. They also gave a description of the methods which enable the station to broadcast sight-and-sound programs on a single wavelength. The sound portion of this special program was broadcast over the entire CBS network as well as W2XAB. All subsequent television programs, however, are confined to W2XAB alone.

A special feature of the sight-and-sound station is the regularly scheduled appearance of a dramatic troupe in especially written playlets for television. Schudt, likening these broadcasts to the talking films, has titled them "tele-talkies."

The Columbia television transmitter was manufactured by the Radio Corporation of America. The technical changes for the sight-and-sound broadcasts, however, were executed by network engineers. The transmitter uses 500 watts power and is assigned to the 2755 to 2845-kilocycle television band. A 60-line scanning disc is used at 20 frames

per second for rebuilding the pictures. The transmitter is located on the twenty-third floor of the system's building at Madison Avenue and 52nd Street, New York City. A special room in the building is set aside for the reception of the sight-and-sound programs for the convenience of visitors.

Before this new plan went into effect, W2XAB used the short-wave transmitter, W2XE, for experimental work on the sound synchronization. At times WABC, the key station, and other network outlets picked up the sound portions of important programs originating in the television studio.

Sight-and-sound programs are now being featured over W2XAB each evening, except Saturday and Sunday, from 8 to 10 o'clock, Eastern Time. Here is a fine chance for experimenters to revise their sets and get in on something new.

Rejectostatic

(Continued from page 275)

items. The coils are mounted on bakelite tubes which are, in turn, mounted in aluminum shields. The condensers in the antenna rejectostat are mounted on a sub-base on which the antenna impedance-matching transformers are also mounted.

Figure 7 shows the complete rejectostatic kit.

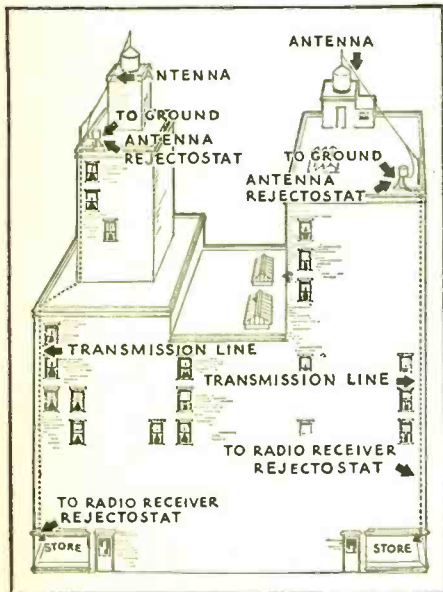

INSTALLATION FOR STORES

Figure 4. Shows the arrangement for installing the Rejectostatic system in stores located on the first floor of tall buildings

The complete system, as shown in Figures 2 and 5, was set up, using a Kolster completely shielded receiver. A standard dummy antenna was substituted for the antenna and voltages were applied to the antenna from a signal generator. The output voltage of the receiver rejectostat for various frequencies in the broadcast band was then measured. The input voltage to the antenna rejectostat was also measured. The ratio of these two voltages is the so-called "transmission ratio."

Curves A and B, Figure 8, show the transmission ratio for a 50 ft. and 400 ft. transmission line as compared to the receiver connected to the antenna alone (unity ratio). Figure 9 shows the sensitivity of the receiver alone and the sensitivity when using 50 ft. and 400 ft. of transmission line.

Tests show that a number of receivers can be operated on a single antenna and transmission line, provided each receiver is equipped with a receiver rejectostat.

"Yes"

(Continued from page 280)

jazz, silly talk, foolish jokes, anything to make a laugh and nothing to educate. And look at the ballyhoo type of radio advertising. The broadcasting stations have had to give in to a considerable extent to these demands, and with the gradual lowering of the prices of radio sets, the better class of human individual will be more and more bombarded with this type of program and may finally succumb to them.

Another instance: Radio has increased the noise in our cities and homes. It is already known that many defects in our work and in our behavior are due to the growing influence of noise. Noise detracts our attention and ruins our nervous systems, although we say we get used to it. The fact is, it damages our nervous system even when we have gotten used to it! The introduction of radio reception stops us from concentrating on our work, our thinking is impaired and our attention toward many other things is affected. The man at the machine in the workshop has his attention distracted and is more liable to hurt himself in a noisy location. Even in motor cars we now listen to music while driving and how anybody can listen to music and drive his car, paying attention to the signals of the other cars, for the whistle of the policeman or the signal lights, is beyond me to state. And there is more to this question of sound and noise than just radio sounds pouring out in hotels, restaurants, shops, business offices and our homes. Experiments have already been made which have shown that the peristaltic movement of the stomach slows down considerably under the influence of noise. In the subway, for instance, it decreases to only a small fraction of its usual time of movement. This means an impairment of our digestion and possibly our "nervous." How many of our gastric and nervous conditions are directly due to the habit of listening to radio after supper?

And I do not need to speak of the interrupted sleep caused thousands because our next-door neighbor does not shut off his loudspeaker during ordinary sleeping hours. I do not need to speak of the harm that comes to people sitting up all hours of the night listening to the radio itself.

Definite statistics show that the number of divorces and murders in cities are in direct ratio to the amount of noise. The noisier the location, like in the lower part of Manhattan, the greater are the number of divorces and human troubles per capita.

Noise and radio, these go hand in hand. They undermine our nerves and those of our children. They undermine our culture. They destroy human tissues. What more can I say. I therefore place these in the category of eminent dangers to the human race and sound the warning that if we do not discontinue our present dangerous, headlong pace in increasing radio operations and of filling the ether with dangerous amounts of radiant energy, we may be degenerated to a race of morons or worse.

"No"

(Continued from page 280)

for the danger to the physician, he knows about it and protect himself. In the Viennese and Jena experiments, the operators wore metallic coverings in their laboratory coats and operating caps to prevent these short rays entering their bodies. Under the proper control of experts—and in the hands of nobody else—these transmitters are a

LYNCH

Noise-Reducing Antenna Products
Solve the Interference Problem

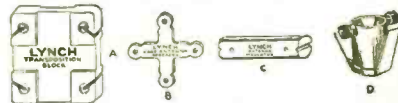

Practically noise-free results on all waves, long and short alike. For the broadcast listener, the short wave and television experimenter and the "amateur." No serviceman should be without these LYNCH Antenna Products which have proved their ability, by test, to eliminate background racket. Ideal for suburbs as well as the most congested city areas. Very simple to "hook-up" to any receiver. Better performance assured.

- (A) LYNCH Transposition Blocks
Extremely durable. Made of "lynchite," a new material, recognized for its great resistance and natural freedom from electrical losses.
Handy Complete Kit of 10 Blocks.....\$2.50
- (B) LYNCH Cage-Aerial Spreaders
For making non-directional and high-gain aerials. Also made of "lynchite."
Handy Complete Kit of 10.....\$2.50
- (C) LYNCH "U. S. Navy Standard" Antenna Insulators
Prevent electrical loss or leakage across the antenna insulators.
Kit of 8.....\$3.00
- (D) LYNCH "All-Wave" Antenna Coupler
Secures best possible results with any of the noise reducing antenna systems recommended by us.
.....\$1.50

LYNCH RESISTORS

METALLIZED 1/2 and 1 Watt 30c List each 2 Watt 40c List 3 Watt 50c List	PRECISION WIRE WOUND 1 Watt Rating 1% Tolerance Values from 1 ohm to 500,000 ohms Write for Prices
POWER WIRE WOUND 3 and 5 Watt 50c List each 10 Watt 65c List 15 Watt 70c List	AUTO RADIO SUPPRESSORS Spark Plug Type Distributor Type Cable Type All Types.....50c List

SERVICEMEN—Discount of 40% from above List Prices

Send order TODAY or write for new, illustrated and descriptive folder.

LYNCH MFG. CO. Inc., 1775N B'way, N. Y.

EXPLORE YOUR MIND

DISCOVER YOUR MENTAL SELF and OVERCOME YOUR LIMITATIONS!

Learn the tremendous possibilities of your own mind. Explore that mysterious world within you. The Free book, "The Wisdom of the Sages", explains how, through fascinating study you can master the every-day problems of life and happiness. Address: Scribe V.I.R.

ROSICRUCIAN BROTHERHOOD
SAN JOSE (A. M. O. R. C.) CALIFORNIA



Learn RADIO

in 10 Weeks in Great Coyne Shops

Come to Coyne here in Chicago and get your training in 10 weeks in our great shops. You are trained by actual work on real equipment so you can enter this great field where fascinating jobs, leading to salaries of \$50 a week and up are common! Manufacturers and dealers need Trained Men! Openings in Broadcasting Stations, etc.

TELEVISION -- TALKING PICTURES

And TELEVISION is already here! Soon there'll be a demand for THOUSANDS of trained TELEVISION men! Get in on the ground floor of Television! Learn Television at COYNE on the very latest Television equipment! Demand in TALKING PICTURES and SOUND REPRODUCTION! You learn ALL these branches of Radio at Coyne.

Get the Facts Free

Mail Coupon Today for all facts. I'll send you my big free book that tells you of jobs and opportunities, also how many can earn while learning and about our free lifetime employment service.

H. C. LEWIS, President
Radio Division, Coyne Electrical School
500 S. Paulina St., Dept. B2-8C, Chicago, Ill.

Send me your Big Free Radio Book and all details of your Special Offer.

Name.....
Address.....
City.....State.....

WORLD-WIDE SHORT WAVE RECEPTION

With New "Reliable" Short Wave Battery Operated Receiver



A Super Sensitive Short Wave Receiver, designed for the reception of broadcasting and code from all parts of the world. The RELIABLE Short Wave Set uses only two tubes: 1-232 and 1-233. You will be amazed at the reception that this set will give you. It is sturdily constructed on a metal chassis and is enclosed in a beautiful crackle finished cabinet. Tunes from 14 to 210 meters, and is extremely sensitive.

\$9.95

Tubes \$2.50 Extra

A SET YOU WILL BE PROUD OF.

CROSBY POWER PACK



Model 104-R Crosley Power Converter, designed for use as the A-B-C power supply for Crosley Band Box Receivers models 602-702. Can be easily adapted for use as power supply for any receiver. Supplies up to 220-volts "H" power. All terminals are brought out to a convenient terminal block. High and low line voltage adjustment built in. Supplied in a neat brown crystalline metal container. These units are all brand new and guaranteed. **Special at \$6.95.**

Send for our latest catalogue FREE!

12 POINT THROW SWITCH
Make and Break 4 Circuits



Ideal for change over on pick up, mike and Radio. Made by Stromberg-Carlson. 4 Pole Double Throw.

TRYMO RADIO CO., INC.

Main Store Branch Branch
85 Cortlandt St. 178 Greenwich St. 179 Greenwich St.
N. Y. Cor. Dey St. N. Y. nr. Cortlandt St.

Get Started in RADIO



Write for free booklet telling about this growing and most promising industry. The radio operator is an officer aboard ship. His work is light, pleasant and interesting. He has many opportunities to travel to all parts of the world.

A new course in TELEVISION now under way.
Full information on request.

EDUCATIONAL DEPARTMENT
WEST YMCA 17 W. 63d St.
SIDE New York

OUTSTANDING

New 4 1/2 Ft. Trumpet
STORMPROOF

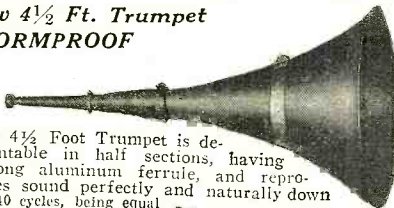

This 4 1/2 Foot Trumpet is demountable in half sections, having a long aluminum ferrule, and reproduces sound perfectly and naturally down to 140 cycles, being equal to that of the 6 Foot Trumpet.

SEND FOR COMPLETE NEW CATALOG ON HORNS AND UNITS
Address Dept. R.N.-11

RACON ELECTRIC CO., Inc.
52 E. 19 ST. NEW YORK
LONDON, ENGLAND TORONTO, CANADA

Radio Noises and Their Cure

by Toke Deu schmann
62 ARTICLES—200 ILLUSTRATIONS

Send 50c for your copy today. (75c Canada and Foreign Countries.)

Newark Electric Co.
"A Radio Service Institution"
228 W. Madison St. Chicago, Ill.

THE MOST COMPLETE LINE OF CONDENSERS AND RESISTORS FOR EVERY RADIO USE

AEROVOX

Write for Complete Catalog free of charge
AEROVOX CORPORATION
78 Washington Street Brooklyn, N. Y.

powerful weapon of humanity against dreaded diseases; at the same time they are rendered harmless to those not concerned, by proper use. While it is true that there exists a biological action of ultra-short waves which was noticed when a radio operator, working at the 3-meter station of the NBC transmitter on top of the Empire State Building, received burns from the ring on his finger, it does not necessarily show that we have to expect danger from an amateur transmitter.

It is not new at all that high-frequency fields develop eddy currents in conductors of electricity, for instance, metal, and that this metal in the direct neighborhood of powerful transmitting stations can be heated to a white glow, if necessary. This operator should have known better. Iron furnaces now work on this principle, as well as tube bombardiers with which we drive out the gas residue from the metals within our radio tubes. But there is a difference. In the latter case we have powerful, commercial transmitters, operated by experienced men and fully under control; they are free from danger, therefore. In the case of the amateur, we have a small set that does not radiate enough power per unit of space to make it a source of danger. So, on the one hand, there is no danger for the layman. And, on the other hand, we have brought these powerful forces under control, making better iron and alloys, better vacuum tubes, treating our sick ones and in making new varieties of plants. These high-frequency currents are, therefore, a valuable tool for mankind, producing no danger if handled properly.

It is just this half knowledge on the part of some laymen that raises a scarehead and points to creative investigation and development as a danger to mankind. The child knows just enough to believe that it knows everything. The scientist is conscious of his limitations; he knows how little he really knows. The layman, not troubled by knowing about the threshold of his actual knowledge, often falls in danger of generalization.

The question of quantity available for making changes in the biochemical composition of tissues holds true also in answering Letter 2. While it is true that our bodies are exposed continuously to cosmic rays, the writer mentions himself that no wall of the strongest constructed building can protect us. For millions of years man and his predecessors have lived under the influence of the cosmic rays, and it has not hurt them. Shall we suddenly get worried about them?

It is just this principle of quantitative consideration that distinguishes the layman from the scientist. True, qualitatively, many harmful effects are in existence. Life itself is nothing but a compromise of a great number of forces opposing each other. But while these forces exist the layman knows little of the quantities in which they exist. But it is the quantity and the direction of the action involved that finally determines where and how the reaction takes place, either in the destruction of living matter or the building up of new capabilities for resisting the influence.

If there were really any detrimental effect of this type of cosmic radiation, the race would have been extinguished a long time ago, so there is no eminent danger of the influences of the cosmic rays. So do not let us worry further about that point.

In Letter 3, the writer is worried whether we are not going to lose our direction-finding instincts by introducing radio-direction finding. I wonder whether this writer, flying in an airship, in the middle of the Atlantic, would prefer to rely upon his sense of direction or to use the direction finder with which it is possible to "nose" directly to a transmitting station.

Much substance is given by the layman, through lack of knowledge, to animal in-

Read Classified Advertising—It Pays

Advertisements in this section twenty-five cents a word for each insertion. Name and address must be included at the above rate. Cash should accompany all classified advertisements unless placed by an accredited advertising agency. No advertisements for less than 10 words accepted. Objectionable or misleading advertisements not accepted. Advertisements for these columns should reach us not later than 1st of 2nd month preceding issue.

TECK PUBLICATIONS, INC.
222 West 39th St. New York, N. Y.

Agents Wanted

MANUFACTURER guaranteed quality Shoes. 28 years in business, wants salesmen. Big profits daily. No experience necessary. Sales outfit free. Write Mason Shoe Mfg. Co., Dept. M-36, Chippewa Falls, Wis.

Correspondence Courses

USED correspondence courses and educational books sold or rented. Inexpensive. Money-back agreement. Catalog listing 3,000 bargains—FREE. (Courses bought.) Lee Mountain, Pisgah, Alabama.

For Inventors

INVENTORS—Sell your inventions before patenting. Use our legal form for recording proof of invention. Write W. T. Greene, 956 Barrister Building, Washington, D. C.

Inventions

INVENTIONS COMMERCIALIZED. Patented or unpatented. Write Adam Fisher Mfg. Co., 278 Enright, St. Louis, Mo.

Microphone Repairs

GUARANTEED MICROPHONE REPAIRS—Any make or Model—24-hour service. Stretched diaphragm double button repairs, \$7.50. Others, \$3.00. Single button repairs, \$1.50. Write for 1933 Catalog with diagrams. Universal Microphone Co., Ltd., Inglewood, California.

Patent Attorneys

PATENTS—Advice and booklet free. Highest references. Best results. Promptness assured. Watson E. Coleman, Patent Lawyer, 724 9th Street, Washington, D. C.

Photography

HAVE YOU A CAMERA? Write for free sample of our big magazine showing how to make better pictures and earn money. American Photography, 3105 Camera House, Boston, Mass.

TRICKS WITH ELECTRICITY



Make electric lights obey voice, make things spin, jump, kick, run, vibrate, buzz, shoot, shock, flash, mystify—all by electricity. Make window novelties, floating rings, spirit rapping, all kinds amusing and practical devices. Book tells how to do 200 stunts with 110 volts A. C. Postpaid \$1.00.

CUTTING & SONS, 112-B St., Campbell, Calif.

KEEP UP WITH RADIO

NEW General course at New York Resident School. Includes all branches of radio, as well as Broadcasting, Sound Pictures, Servicing, Aviation and Marine Operating. Also specialized courses at New York and Chicago schools. Catalog on request.

RCA INSTITUTES, Inc.
Dept. RN-11, 75 Varick St., New York



All Parts Carried in Stock for
The D. L. VanLeuvan
POCKET DIAGNOMETER
Using the POINT TO POINT SYSTEM

Wholesale Prices on Request

SUN RADIO COMPANY
64 Vesey Street New York

HUGE SAVINGS IN USED PUBLIC ADDRESS EQUIPMENT

Send for bargain lists. Motion Picture and Sound Systems.

SALES ON SOUND CORP.
Dept. RN, 1600 Broadway, New York

stinct. This refers as much to weather, as to direction, etc. Last winter, for instance, the Society for the Prevention of Cruelty to Animals in Austria sent several carloads and several freight airplanes, filled with cages of swallows, to the South. These swallows simply had been surprised by the sudden start of the cold weather and were sitting shivering in country places wherever they could find some sort of shelter. Barns and haylofts were full of them. This was not an accident of one or two swallows. Thousands of these birds *did not* find their way and would have been frozen to death if good-hearted people had not sent them by freight to their sunny winter locations.

As to the instincts of guides, the bleached bones of many a caravan tell the traveler, in Arizona as well as in the Sahara or in the Gobi Desert, some of the many mistakes made by desert travelers who paid with their lives for a lack of directional instinct which had been lacking long before the invention of radio.

Today, with radio antenna systems, we

are in a position to actually locate our position, over land and over water. The Atlantic fliers consider their radio equipment one of the most important helps in crossing the sea.

As to the reliability of science against instinct, this refers also to Letter 6, in which the writer speaks about radio ore locators and the divining rod. The location of minerals and oils is now accomplished by the geologist who works with the co-operation of the exact physicist. The leading companies of this country and others have invested millions of dollars in this type of electrical prospecting equipment because they simply cannot afford to rely upon instinct.

Where heavy commercial interest exists, when the decision has to be made where to invest considerable sums in drilling a hole thousands of feet deep—only the actual knowledge and the facts count—not instinct.

As for Letter 4, is it really necessary to discuss crystal-gazing. In spite of the fact that this profession, according to well-informed statements, draws around twenty

RADIO NEWS Export Service

AS a service to our readers in locations outside the United States of America, either commercial, professional or private individuals, RADIO NEWS will arrange to provide contact with leading American manufacturers of radio supplies and receiving equipment.

To utilize this service, clip and fill out coupon below and send it attached to your letter on which you list the types of apparatus you are interested in.

Our Export Service Department will refer your inquiries direct to the proper manufacturers, asking them to send you full particulars, catalogues, prices, etc.

ALS einen Dienst für unsere Leser, entweder Kaufleute oder Privatpersonen ausserhalb der Vereinigten Staaten von Amerika, kann RADIO NEWS mit den führenden Amerikanischen Fabrikanten von Radio Apparaten Kontakt herstellen.

Für den Gebrauch dieses Dienstes schneide man den Kupon aus und sende denselben mit einer Liste von Apparaten die für Sie von Interesse sind.

Unsere Export Abteilung wird Ihr Schreiben umgehend an die betreffenden Fabrikanten weiter befördern, mit der Bitte Ihnen Auskünfte, Preise und Kataloge zu senden.

POUR rendre service à nos lecteurs demeurant hors des Etats-Unis d'Amérique (commerçants, professionnels ou particuliers), RADIO NEWS vous fera entrer en relation avec les principaux fabricants d'appareils de T. S. F. en Amérique.

Pour profiter de cette organisation, il vous suffira de remplir et de découper le coupon ci-joint, et de l'envoyer attaché à votre lettre, en énumérant les types d'appareils qui vous intéressent.

Notre service d'Exportation fera suivre directement vos demandes aux fabricants intéressés en les priant de vous adresser tous renseignements, catalogues, prix, etc. . . .

COMO un servicio especial a nuestros lectores que se encuentran fuera de los Estados Unidos de America, ya sean comerciantes, profesionales o personas privadas, RADIO NEWS tendra a bien ponerlas en contacto con los principales centros manufactureros de radio, de aparatos receptores y accesorios.

Para beneficiarse de tal servicio, sirvase recortar el coupón de esta página, enumere los tipos de aparatos que le interesen, y envíenosla con su carta.

Nuestro Departamento de Exportación se encargará de ponerse en contacto directo con dichos centros, pidiendo le envíen información completa, catalogos, precios, etc.

RADIO NEWS Export Service Department

Kindly put me in contact with American firms manufacturing the class of radio apparatus noted on attached sheets.

Name.....

Address.....

Business.....

The New SHALLCROSS General Purpose Meter No. 610



provides facilities for a wide range of electrical measurements not usually possible in one instrument.

Employing a No. 610 Shallcross Resistor Kit and the Weston Model 301 Universal Meter, this combination meter measures:

- 4 D.C. Voltage Ranges
- 4 D.C. Current Ranges
- 4 A.C. Voltage Ranges
- 4 A.C. Current Ranges

Resistance measurements of 1 ohm to 3 megohms

Inductance measurements, 1 to 10,000 henrys

Capacity measurements, .001 to 10 mfd.

Output Meter

Send 6c in stamps for Bulletin 152-D which contains a diagram of this circuit and information on its construction.



NEW Combination AUTO Radio AERIAL and Sun Visors

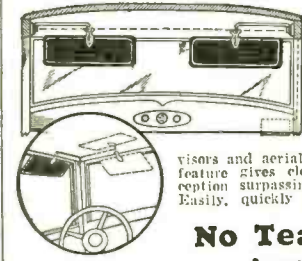

VIZOR - TENA does away with tearing up auto top and gives a perfect auto radio aerial in a pair of sun visors . . . highest grade. 4-way adjustable sun visors and aerial all in one. Aerial feature gives clear, undistorted reception surpassing any now in use. Easily, quickly installed.

No Tearing Up Auto Top SAVES 1/3

Ball and Socket hinge—easily, quickly adjusted, either to side or front, or up or down.

in cost and work over roof-type aerial. Thousands installing auto radios—BIG DEMAND for this simple, efficient and economical, double-duty radio aerial and sun visor.

Write Quick for FREE Test OFFER so you can try this wonderful VIZOR-TENA on your car for 10 days at our risk. We also want salesmen, dealers, distributors, and have a wonderful money making opportunity for agencies open. Write quick for Special Introductory Trial Offer.

VIZOR-TENA CO.

212 Balcony Bldg. Kansas City, Mo.

CONDENSER MICROPHONES

CONDENSER MICROPHONE AMPLIFIERS

Complete condenser microphone kit including all parts to build condenser microphone of high quality output, \$3.00.

Completely assembled and tested microphone and amplifier, including "C" battery and 5-wire cable, housed in aluminum shield case. This condenser microphone is capable of high quality reproduction of voice and music. Price \$20.00.

(Above Prices P. P. on Receipt of M. O.; (C. O. D. Extra)

PARTS FOR DYNAMIC MICROPHONE

(Sent Radio News)
CHRISSELL-ACOUSTIC LABORATORIES
175-68th Street Brooklyn, N. Y.

INDEX TO ADVERTISERS

A	
Aerovox Corp.	316
Alden Products Co.	318
Allied Radio Corp.	319
American Sales Co.	311, 314
Amperite Corp.	307
Amy, Aceves and King, Inc.	311
B	
Bud Speaker Co.	309
Burstein-Applebee Co.	318
C	
Candler System Co. The	318
Capitol Radio Engineering Inst.	308
Cardwell Mfg. Corp., Allen D.	310
Central Radio Labs.	304
Chrisell-Acoustic Labs.	317
Clark Co. L. M.	319
Clarostat Mfg. Co., Inc.	320
Coast to Coast Radio Corp.	308
Coyne Electrical School	315
Cutting & Sons	316
Classified	316
D	
Deutschmann Corp. Tobe	313
Dubilier Condenser Corp.	312
E	
Electrad, Inc.	311
Electrical Sound Inst., Inc.	320
Evans & Co., Victor J.	306
F	
F & H Radio Laboratories	314
Federated Purchaser, Inc.	302
G	
Globe Television & Phone Corp.	312
Grant Radio Labs.	312
H	
Hammarlund-Roberts, Inc.	313
Hoodwin Co. Chas.	307
I	
International Correspondence Schools	320
International Resistance Co.	303
K	
Kenyon Transformer Co., Inc.	314
Kester Solder Co.	308
L	
Lew Bonn Co.	308
Lincoln Radio Corp.	Second Cover
Lynch Mfg. Co., Inc.	315
Mc	
McGraw Hill Book Co. Inc.	310
M	
Massachusetts Radio & Telegraph School	302
Metal Cast Products Co.	320
Mid-West Radio Corp.	264, 265
Miller & Miller	306
N	
National Co., Inc.	263
National Radio & Electrical School	301
National Radio Institute	260-261
National Union Radio Corp.	299
Newark Electric Co.	316
O	
O'Brien, Clarence A.	306
Ohio Carbon Co. The	295
P	
Polk & Co. R. L.	320
Postal Radio Co.	320
R	
RCA Institutes, Inc.	310, 316, 319
Racon Electric Co., Inc.	316
Radio Receptor Co., Inc.	302
Radio Technical Pub. Co.	318
Radio Trading Co.	304
Radio Training Assn. of America	257
Radio Treatise Co., Inc.	307
Readrite Meter Works	297
Rosicrucian Brotherhood	315
S	
Sales on Sound Corp.	316
Shallcross Mfg. Co.	317
Scott Radio Labs., Inc., E. H.	259
Silver-Marshall, Inc.	Fourth Cover
Sun Radio Co.	316
T	
Taussig, Leo	312
Telex Co.	306
Trimm Radio Mfg. Co.	302
Tryno Radio Co., Inc.	316
V	
Van Leuven, D. L.	304
Vizor-Tena Co.	317
W	
Webster Co., The	307
Weston Electrical Instrument Corp.	305
West Side Y M C A. Radio Institute	316
Wholesale Radio Service	309
Wonder Specialties, Inc.	318
World Microphone Co.	306

2 GREAT BOOKS THAT WILL BRING YOU MORE MONEY

RADIO PHYSICS COURSE by A. A. Ghirardi **\$3.50** Postpaid in U. S. minute! Up-to-the-minute radio text book, compiled by the most contributing Editor of Radio News and a radio instructor of note. 992 pages. Over 500 illustrations.

RADIO SERVICING COURSE by Bertram M. Freed and A. A. Ghirardi **\$1.50** Postpaid in U. S. Practical! Valuable! Check out of the technical information, diagrams and suggestions every serviceman needs in order to keep up to date.

MAIL THIS COUPON AT ONCE!

RADIO TECH. PUB. CO., Dept. R.N. 11, 80 Fifth Avenue, New York City.

Enclosed find check, cash or money order for _____ copies of Radio Physics Course at \$3.50 each, and _____ copies of the Radio Servicing Course at \$1.50 each. Check here for FREE circular

Name _____
Address _____
City _____ State _____

You Can Become a Fast, Capable RADIO OPERATOR at Home

CANDLER Scientific System

In less than half the usual time. Amazing results. Thousands of fast Radio operators taught by CANDLER. FREE advice if you're "stuck."

All questions answered personally. No obligation. If beginner, get facts on Junior Course. If Radio operator, ask about **ADVANCED COURSE for SPEED and Copying Behind** and "MILL" Course. FREE illustrated book will save you time and money. Write now!

CANDLER SYSTEM CO., Dept. 18
6343 So. Kedzie Ave., Chicago, Ill.

World's Only Code Specialist

NEVER BEFORE has \$1 BOUGHT SO MUCH ENTERTAINMENT

LITTLE WONDER MICROPHONE

Pop up the radio programs with the **NEWEST AND GREATEST RADIO TUNER**. Make the family and guests roar with laughter by interrupting chain broadcasts to make witty and clever remarks of your own. Be your own announcer. Convert your home into a broadcasting studio. Develop your radio talent.

Attach a **LITTLE WONDER "MIKE"** to your radio and hear your own voice through your radio loud speaker. Easily attached. Does not distort tone, interfere with reception nor injure tubes. For sale by leading drug, hardware, radio, department and 5c to \$1.00 stores or sent postpaid for only \$1.00. Don't accept imitations. **LITTLE WONDER MICROPHONE** is the real thing.

WONDER SPECIALTIES, INC.
1102 C A C Building Cleveland, Ohio

NA-ALD Get the latest dope on the new 6-prong analyzer plugs, adaptors and sockets for all the new tubes including the 7-prong.

Send stamp for chart showing the adaptor to use for testing new tubes with your present analyzer or checker.

ALDEN PRODUCTS CO. Dept. N. Brockton, Mass.

FREE Amateur and Servicemen's Wholesale Guide —Hot off the press! Check full of latest of everything for the Radio Serviceman, Amateur, Experimenter. Detailed illustrations, vital and interesting facts. Hundreds of "Hot Shot" bargains! Astonishing wholesale prices that challenge all America. WRITE TODAY for your free copy!

BURSTEIN-APPLEBEE COMPANY
1408 C McGee St., Kansas City, Missouri

million dollars a year from a believing American public, I can only state my case in this way: If crystal-gazing were a real scientific possibility, would it not have been adopted and used commercially as well as by the police for locating criminals, long ago?

Always man has invented machines that would do away with useless effort. The machines finally have made man the master of the world, as long as he really reigns these machines. With this new device of radio, a new and important field for defying space is thus opened to humanity.

And as far as noise is concerned, radio has helped in many instances to relieve the monotony of work and therefore has been introduced into factories where monotony has threatened to reduce the quality of the work of the operators. As far as the divorce question is concerned, it certainly is not only noise or a lack of noise, but many other things in combination that bring about the true foundation for the continuation of marriage.

Are man's instincts degenerating? Quite the contrary, man's brains have created new tentacles to feel and search where his five senses do not give him exact knowledge or sensation. Man's brain has given him more than nature has provided for him originally. No, radio is not making us a race of morons; it has added to our knowledge a most important item and has given us a new tool for digging deeper into the abyss of our little universe, our world.

With the Experimenters

(Continued from page 299)

power relay, ringing an alarm bell and opening the main power supply circuit.

A voltmeter connected and equipped in this way can be made to act as an automatic circuit breaker. For laboratory experiments and tests of extreme precision, this plan could undoubtedly be used in conjunction with a mirror galvanometer, so that extremely minute currents could be made to control the action of power relays.

When used with a pyrometer, a pre-determined temperature level can be made to operate an alarm, to turn off the current from an electric furnace or to perform other equally important functions. Another suggested use of the above idea would be in connection with a speedometer, whereby a small electric motor could be stopped or started through the action of the power relay. The motor could be arranged to open or close a valve, thus regulating the flow of steam or gas to an engine, and hence the speedometer and Photronic relay would serve as an automatic governor.

Low Impedance Pick-ups in High Impedance Circuits

One of my customers had an RCA 18 combination radio-phonograph. He decided to buy a later model chassis and after installing this chassis we found that the low-impedance phonograph pick-up of the old combination would not operate with this new chassis. The RCA, Brunswick and General Electric combinations use low impedance type pick-ups.

My customer not wishing to purchase a new pick-up, I set about to convert the old pick-up for use with the new chassis. I obtained a double-button microphone transformer and wired the pick-up to the microphone side and connected the secondary to the "phono" posts on the new chassis. This did the trick. Later I tried using a 12-volt bell-ringing transformer for the same purpose and even that arrangement worked.

W. T. GOLSON,
Dothan, Ala.

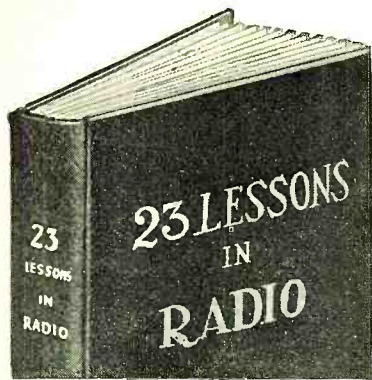

FREE

With this New Money-Saving Offer From RADIO NEWS

SO many requests have come into this office asking us to repeat our popular subscription offer which included the gift book—"23 Lessons in Radio"—that we have finally been forced to print a new edition. It is now ready for you!

"23 LESSONS IN RADIO" is not for sale anywhere! But by subscribing through this special offer, you receive not only this great book FREE, but you also receive five copies of RADIO NEWS for only \$1—or if you prefer to—you may purchase eleven months for \$2—(a saving of \$1.75 over the single copy price). Simply fill out the coupon below and send it to us with the proper remittance.

We will immediately mail your "23 LESSONS IN RADIO" and your first issue of RADIO NEWS. If you are already a subscriber, be sure to indicate this on the order blank so that your subscription is extended accordingly.

A Few of the Subjects Covered:

- Elementary Radio Theory
- How the Detector Tube Works
- Construction of a Two-Stage Audio-Frequency Amplifier
- How the Radio-Frequency Amplifier Works
- How to Build a "Converter" Which Changes Your 5-Tube Broadcast Receiver Into a Short-Wave Receiver
- Principles of Transmitting and Receiving
- Complete Chart of Standard Radio Symbols
- How to Build R F Tuner
- How to Build a Three-Stage Resistance Coupled Audio-Frequency Amplifier
- The How and Why of B-Power Units
- Breaking Into the Amateur Game
- How to Build a Code Test Outfit
- Circuit, Constructional and Operating Details of a Low-Power Transmitter
- How the Vacuum Tube Works
- Battery Construction Details
- How to Analyze Receiver Circuits

RADIO NEWS, Dept. 11A
222 W. 39th St., New York, N. Y.

Enter my subscription for RADIO NEWS, and send me the book, "23 LESSONS IN RADIO."

Check offer desired:
 5 Issues \$1.00 Enclosed (Foreign and Canada, \$1.50)
 11 Issues \$2.00 Enclosed (Foreign and Canada, \$3.00)

Name.....

Address.....

City..... State.....

If renewal check here
 Are you a Serviceman Engineer Dealer
 Experimenter Radio Technician

The Service Bench

(Continued from page 297)

ment is often a tedious matter of cut-and-try. Appreciating the desirability for some means of rapidly determining the correct resistor value, the writer has designed a simple arrangement consisting of a calibrated variable resistor which can be temporarily substituted for the defective unit.

"The variable resistor is preferably of the wire-wound type (fairly high wattage) from zero to 250,000 ohms. For greater elasticity and accuracy it would be desirable to use two resistors, one for low ohmages, from zero to 10,000 ohms, and the other for higher values. —Ed.) The variable resistor is mounted on a small panel and equipped with a pointer and scale. It will be convenient to supply two flexible leads terminating in clips. The resistometer is calibrated by means of an ohmmeter or a milliammeter and a known voltage in accordance with Ohm's Law, which states that the resistance in ohms equals the voltage divided by the current in amperes. Corrected for milliamperes, the equation reads $R = E \times 1000/I$. The calibration may be either direct reading or by comparison with a simple chart.

"The use of the resistometer is obvious. The instrument is connected in place of the defective resistor, and adjusted for best reception without exceeding recommended operating voltages. The correct resistance value is noted and the replacement effected with the nearest available fixed value."

ALL IN THE DAY'S WORK

The service department of the Philco Radio and Television Corporation passes on the following data, both general and specific:

Testing for Intermittent Opens in Bypass Condensers

"Intermittent operation or 'cutting-out' is sometimes caused by loose internal contact in one of the bakelite bypass condensers. This condition can be tested quickly by using a special probe to examine the joint between the wire and the tin-fil ends of the internal condenser unit. A steel needle with the point broken off can be attached to a piece of insulating material such as wood, fibre or micarta. The internal connections of the condenser can be probed for faulty contacts by inserting the needle through the eyelet holes in each end of the black bakelite container."

Public Address Profits Microphone Mixing Panel

RADIO NEWS has repeatedly called to the serviceman's attention the money-making possibilities presenting themselves in the public-address field from the standpoint of owning, renting, selling and servicing portable and stationary systems.

Now comes Mr. J. M. Montross of Watervliet, New York, one of our readers, and a live wire if there ever was one, with the interesting news that he has just completed the largest individually owned sound truck in existence, a truck 12 feet longer than the largest Greyhound bus on the road—12½ feet high.

Mr. Montross, a pioneer in the sound advertising service in his section of New York State, has not only visualized the tremendous possibilities in sound-truck advertising, but he's already cashed in on these possibilities. Realizing that his sound advertising service is in its infancy and knowing that the future holds promise of even greater

Your Copy is Ready



Service Men—Write for your FREE Copy of our 1933 Radio Catalog

LOWEST WHOLESALE PRICES

80 Pages of everything you need in Radio. Complete stocks of the highest quality replacement parts, tubes, test equipment, and accessories at the lowest wholesale prices.

UP-TO-THE-MINUTE SERVICE

Our tremendous stocks and efficient organization are waiting to serve you promptly, courteously, and efficiently.

Write today for your FREE COPY of our 1933 Service Men's Radio Catalog.

ALLIED RADIO CORPORATION

831 W. Jackson Blvd. Chicago



MORE CAPACITY AT LESS COST

Latest research by oldest condenser manufacturer is reflected in present line of

DUBILIER ELECTROLYTICS

Available in all types—round and square metal cans, cardboard containers, tubular paper wrappings, high-voltage, low-voltage, tapped units, etc. Positively guaranteed for quickest reforming time, lowest leakage, highest working voltage, longest life. And they cost less!

Write for literature on Dubilier Electrolytics as well as all other types of condensers.

DUBILIER CONDENSER CORPORATION

4377 Bronx Blvd. New York City

HERE'S a Compact AERIAL



This amazing device replaces your aerial and stops troubles due to aerial. Kills noise; reduces static; sharpens tuning; eliminates lightning hazard. Easily installed. Improves radio reception amazingly. 5-day trial on money back guarantee. Send \$1 for Aerialator prepaid or pay postman \$1 plus postage.

L. M. CLARK COMPANY
 Dept. 06, P. O. Box 900 Toledo, Ohio
 (Jobbers, Dealers, Agents. A money-maker. Send for details.)

HERE'S YOUR RADIO COURSE!

What branch of radio do you want? We have courses that fit you for any practical radio engineering problem. The new General Course includes: Broadcasting, Marine Operating, Servicing, Aeronautical Radio, Short Wave Developments, Sound Motion Pictures, Studio and Home Recording, Applications of "Electrical Eye." New York and Chicago residential schools. Catalog.

RCA INSTITUTE
 Dept. RN112 75 Varick St., New York
 A Radio Corporation of America Subsidiary



Perpetual Test Adapter

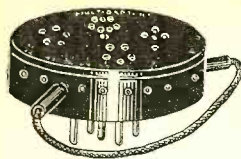

NEW FEATURE TAKES THE PLACE OF FIVE, SIX and SEVEN prong tubes developed in the future. Fits all standard and custom-built set analyzers and tube testers. Permits the testing of all new tubes, including the types 29, 33, 34, 39, 41, 42, 43, 44, 46, 47, 51, 55 (diode), 56, 57, 58, 64, 65, 67, 69, (both plates of 80, 82, 85), 85, 89, Wunderlich, 91 (strip-twin), 93, and 95.

Dealers and Servicemen **NET PRICE \$2.75** Post-MONEY BACK GUARANTEE

Send no money. Pay the postman.

FREE New tube charts and socket layouts supplied by Postal Radio with each adapter. Dealers, Servicemen, and Experimenters send 3c stamp for our 1933 General Catalogue.

POSTAL RADIO

133-137 Liberty St., New York, N. Y.

WHAT YOU NEED TO SUCCEED IN RADIO

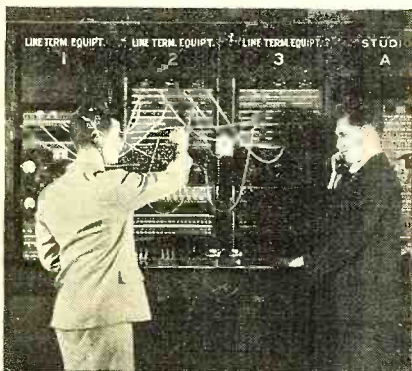

Courtesy of the National Broadcasting Company

RADIO is a highly specialized business. As it develops it is becoming more exacting in its demands. But radio is the modern field of opportunity for those who keep step with its progress!

There is a great need for *trained* men in the radio industry. There is no place for *untrained* men. Experience must be accompanied by technical knowledge.

A pioneer in home study, the International Correspondence Schools have kept pace with the times and offer courses which give practical instruction in fundamentals and latest developments alike. The courses were prepared and are constantly revised by the Who's Who of Radio!

Composed of 24 basic divisions, the Complete Radio Course covers the whole field of radio. The I. C. S. Radio Servicing Course was prepared specially for men who wish to become service experts, and win over competition. The I. C. S. Radio Operating Course is vital to mastery of operating and transmitting.

We will be pleased to send you details of any or all of these subjects. Just mark and mail the coupon—the information will be forwarded at once. Do it today—*now!*

INTERNATIONAL CORRESPONDENCE SCHOOLS
Box 8284-L Scranton, Pa.
Without cost or obligation, please tell me all about the NEW RADIO COURSE

Name _____ Age _____
Street Address _____
City _____ State _____
If you reside in Canada, send this coupon to the International Correspondence Schools Canadian, Ltd., Montreal, Canada

things, he's gone after this sound advertising business in a really big way—bigger, perhaps, than any individual has ever done before. Imagine a sound truck equipped with double deck and housing in the upper deck living-room, kitchen, dining-room, bathroom and sleeping quarters!

Mr. Montross built and designed the special amplifier for use in this installation, and to give you some idea of how well his sound installation performs, he tells us that at a Washington Bi-Centennial at Utica, New York, a few weeks ago, a sound engineer acquaintance of his picked up his voice clearly three-quarters of a mile away, over the heads of 3,000 people. Mr. Montross selected Bud dynamic units and Bud all-aluminum 6-foot trumpets.

This bus will be on exhibition at the New York State Fair at Syracuse and numerous other fairs this year. If Mr. Lehman runs for Governor of New York State, Mr. Montross and the bus will tour the State with him.

Portable Public Address

In recognition of the expanding use of public-address equipment, due to exploitation by the individual serviceman, the United Sound Engineering Co. has developed their

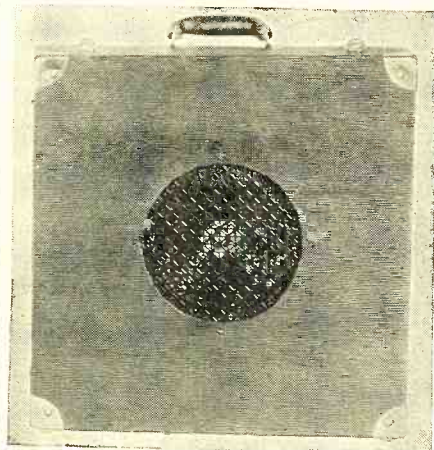

FIGURE 4

type U-9 portable public-address system, shown in Figures 4 and 5. The speaker—a Wright deCoster—is mounted in one side of the carrying case and the amplifier in the other. The U-9 amplifier, while primarily



FIGURE 5

designed as a public-address amplifier, is equally effective in sound-on-film work and broadcast remote control.

Insure YOUR WORK

with

CLAROSTAT Replacement VOLUME CONTROLS

CLAROSTAT Replacement Volume Controls are "Custom-made" to exactly suit the receivers for which they are offered. Not a makeshift job lot idea. The resistance, taper, shape and shaft are made according to the proper specifications. There is no delay in installing them. There are no comebacks when you use CLAROSTAT products.

CLAROSTAT Mfg. Co.
285-287 N. 6TH ST. BKLYN. N.Y.

MAILING LISTS

Pave the way to more sales with actual names and addresses of Live prospects.

Get them from the original compilers of basic list information—up to date—accurate—guaranteed.

Tell us about your business. We'll help you find the prospects. No obligation for consultation service.



FREE 60 page Reference Book and Mailing LIST CATALOG

Gives counts and prices on 8,000 lines of business. Shows you how to get special lists by territories and line of business. Auto lists of all kinds. Shows you how to use the mails to sell your products and services. Write today.

R. L. POLK & CO.
Polk Bldg.—Detroit, Mich.
Branches in Principal Cities

World's Largest City Directory Publishers
Mailing List Compilers. Business Statistics. Producers of Direct Mail Advertising.

Get Into the Toy Business



As Our Manufacturer
Earn Money casting our new hollow Toy Soldiers, Indians, 5c and 10c Automobiles, Ashtrays, etc., for a firm of many years standing. NO EXPERIENCE required as we furnish full instructions with moulds and buy unfinished goods. A rare opportunity for these times, so if you mean strictly business write at once for full details as CHRISTMAS RUSH is Now Starting.

Metal Cast Products Co.
169c Boston Road

Dept. 12
New York

TELEVISION

Are you completely informed on the recent advances and developments attained in this science?

ELECTRICAL SOUND INSTITUTE, Inc.
Easton, Pa.

THIS BIG CASH SAVING OFFER BRINGS YOU THIS VALUABLE BOOK **FREE**

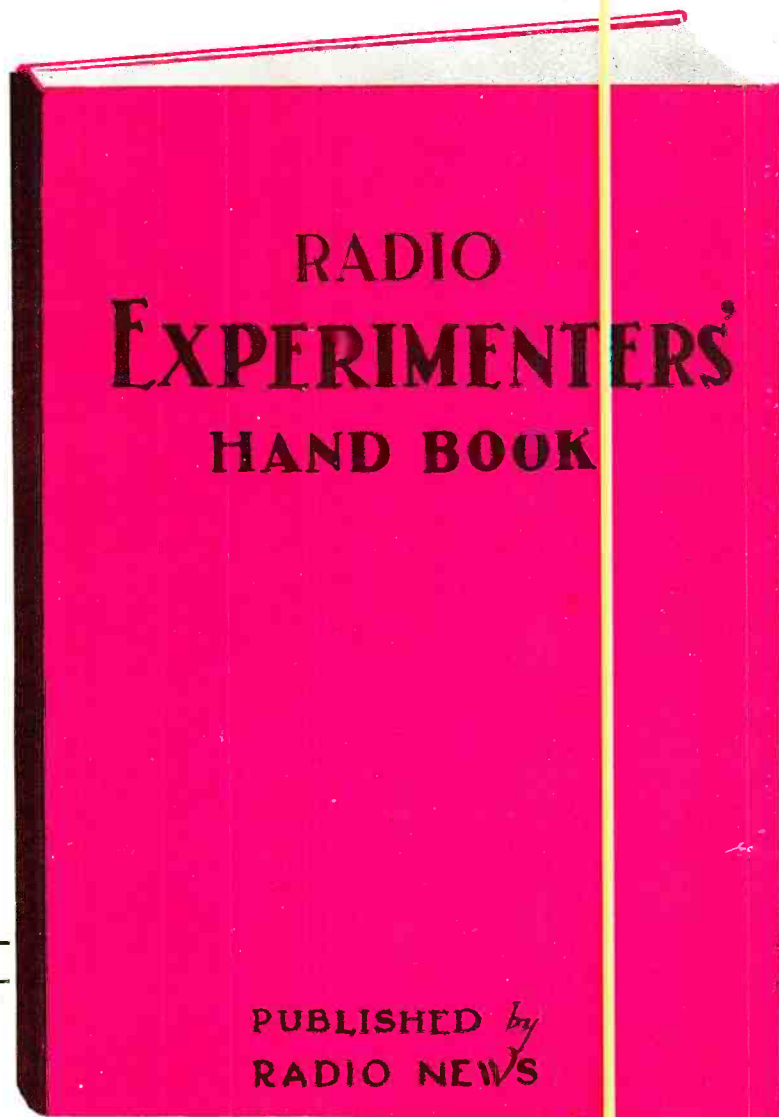

WITH
RADIO NEWS

EVERY radio man—experimenter, serviceman, laboratory technician, engineer, professionals and amateurs alike, will want this book. You will want to have it on your work bench at all times.

It contains a vast fund of radio information in one compact pocket-size reference volume, embracing—Radio Design, Electrical Measurements and Measuring Equipment, Laboratory Hints and Kinks, Television Information, Photo Electric Cell Principles and Applications, Short-wave Design, New Hook-Ups, Charts, Tables, and Diagrams.

The entire book is carefully written in clear understandable language that any radio enthusiast can digest readily. It is profusely illustrated with accurate diagrams, charts, curves, sketches and photographs. Prepared in convenient pocket reference size, it fits easily into the kit bag, and its stout Red Bristol binding will withstand the usage of the work bench.

For a limited time, Radio News is offering this book absolutely FREE with a subscription for eleven issues, for \$2.

THE COUPON SAVES YOU 8.75

And that is not all—in addition to securing the book FREE, you save 75c on your subscription, as these eleven issues purchased on the newsstands would cost you \$2.75.

Partial List of Contents

LABORATORY METHODS AND EXPERIMENTS There are chapters including valuable information on running an experimental laboratory, including laboratory procedure methods, hints, shop kinks, and hundreds of actual experiments. Other chapters contain information on photo-electric principles, operating data and usage, including technical data on various types of photo-electric tubes, relays and associated apparatus.

TELEVISION Television is discussed from the developmental and design standpoint including charts and formulas for laying out optical systems, wide band amplifiers, and reproducing apparatus.

ELECTRICAL MEASUREMENTS This chapter contains profuse data and actual methods of procedure for measuring a.c., d.c., and r.f. voltage and current;—the calculation of shunts and multipliers for measurement work;—resistors needed for multipliers for various ranges;—a complete set tester and analyzer, using condensers as multipliers;—the use of and construction of thermo-couplers;—the vacuum tube voltmeter;—measuring small resistances;—the use of ohmmeters and the slide wire bridge;—measurements of inductance capacity;—construction and usages of a micro-farad meter;—ranges and series resistances on capacity measurements;—measurements of resistance of coils and condensers at radio frequencies;—frequency measurements and meters;—the incremental method;—stroboscopic methods;—measurement of tube characteristics;—bridge methods;—mutual conductance;—the use of a mutual conductance meter;—modulation meters and their uses;—hum measurements and elimination; output meters.

SHORT WAVES There are chapters on short-wave design and specific information regarding the short-wave field—invaluable help to the short-wave fan and enthusiast, including the latest transmitting and receiving applications and developments.

RECEIVER DESIGN Other sections deal with the elements of practical design in receivers and radio parts. Amongst the data in this section appears information on the design of resistors, design charts for conductance and capacity as well as resistors, frequency, etc.;—design of condensers for special purposes;—design of apparatus and curves on coils for different physical sizes and varying inductances; design of single layer coils;—formulas for design of inductance;—design of transformers for power applications;—radio frequency transformer design;—tube

design and tube characteristics;—the triple-twin tube;—design data on all modern tubes;—complete tables of all tubes, both old and new for receiving, transmitting, oscillator, etc.;—elementary circuit design;—short wave superheterodyne problems;—automatic volume control;—voltage divider design;—audio system design charts;—audio design with respect to tube output considerations;—charts on tuned circuit design;—beat frequency oscillator design;—oscillators designed for service work;—relays designed for the experimenter;—design and information on the grid glow tubes;—design and information on photo-electric and electronic devices using sound and visual methods of operation.

NEW HOOK-UPS

New circuits and hook-ups are described, ranging through the whole field of radio, transmitting, receiving, and specialized circuits from all branches of the art.

CHARTS DIAGRAMS

And there are numerous other chapters containing general information, charts and diagrams, as vital and important to the radio man, both professional and amateur, as those briefly mentioned here.

RADIO NEWS, Dept. 11,
222 W. 39th St., New York, N. Y.

Enclosed is \$2. Send me the "Experimenters' Hand Book" as soon as it is printed and enter my subscription at once for the next 11 issues of Radio News. If renewal subscription check here ().

Name

Address

City State

Canadian Price \$2.50

Foreign Price \$3.00

SM

For the first time in history a receiver is guaranteed to outperform, on every count, any other radio right in your own home—or your money back!

Mrs. Murdo Silver
McMurdo Silver

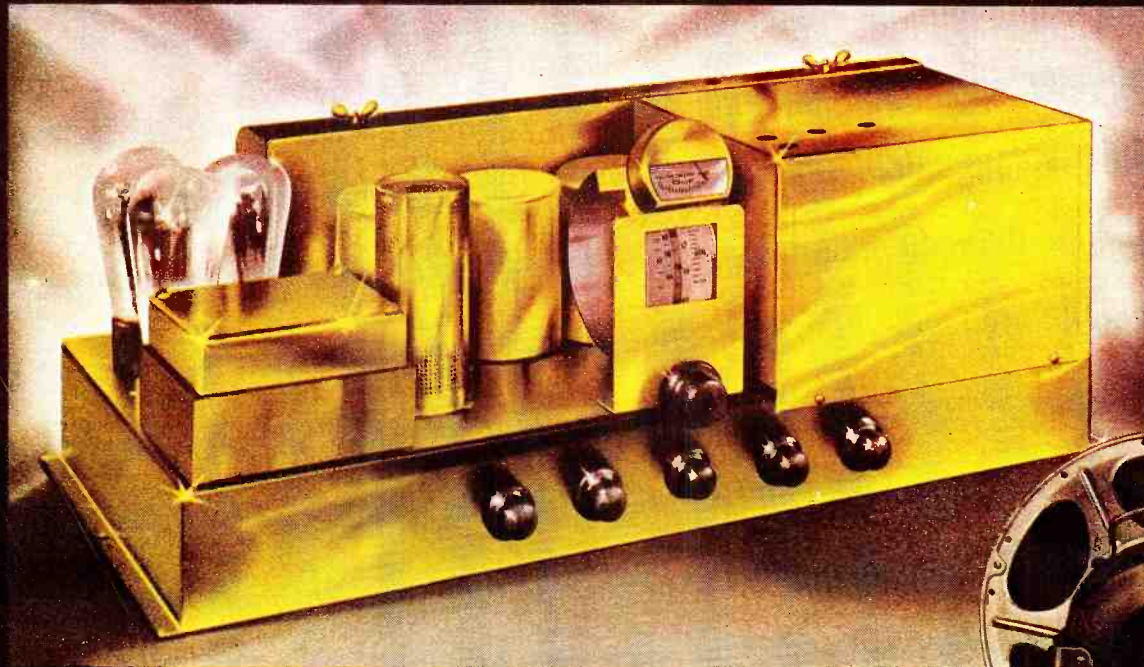

**The
NEW
CB-1**

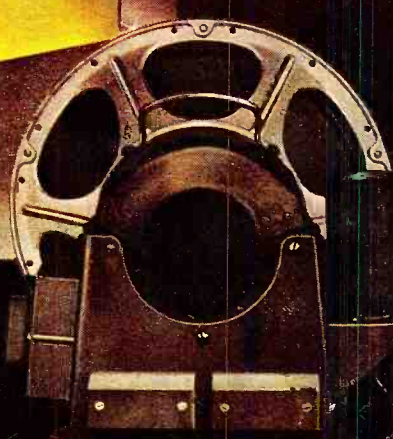

If the finest of anything can have a price—that should be the price of the CB1. It is Silver-Marshall's *Custom-Built* sister radio to the 728SW. It has 13 tubes with "bong" enough to fill a cathedral. Its speaker is an exclusive new auditorium model that, alone, weighs 42 pounds, with a voice coil 2½ inches in diameter—equivalent to 4 ordinary speakers and an extra stage of audio. That speaker is rated at 15 watts, giving the receiver an all-wave sensitivity almost impossible to measure.

Into the CB1 has been built every feature known to the S-M Laboratories. And they have produced 39 major radio developments in the last eight years!

We could go on for pages listing its technical perfections. No wonder it is brass plated, brushed, buffed and lacquered like the finest laboratory instrument. It is a laboratory instrument. And each one personally tested and approved by McMurdo Silver.

Available both as a matched assembly installed in a beautiful accoustically selected cabinet and as a chassis.

And remember—guaranteed to outperform anything at any price—or your money back.

Why is Silver-Marshall Custom Built equipment used by the United States Navy on the Akron, the largest dirigible in the world?

Why is it used as official equipment by important airports in all parts of the country?

Why do you find it on famous sea-going private yachts?

Why is it selected by the Chief Engineers of almost every important broadcasting station?

Write for technical description, logs of world-wide reception and prices.

SILVER-MARSHALL, Inc.

6405 WEST 65th STREET « « » » CHICAGO, U. S. A.